

AIU-4 Installation Manual

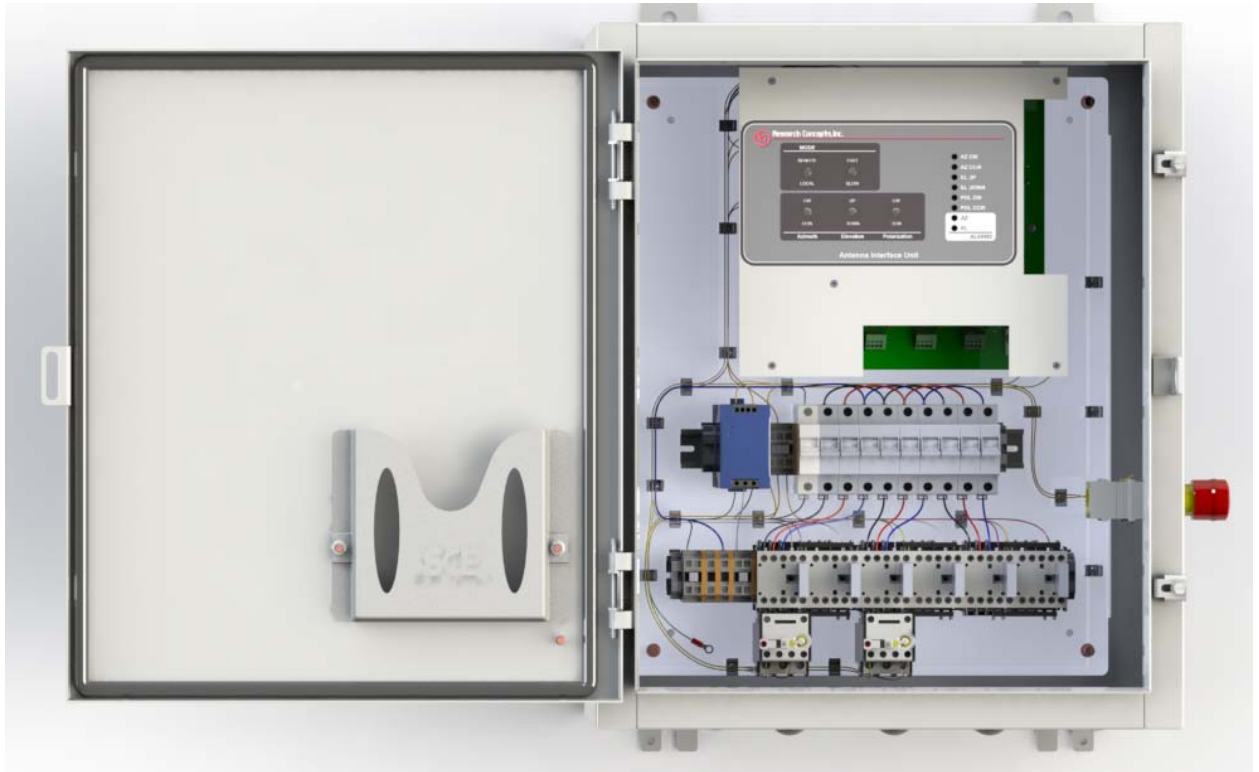

RESEARCH CONCEPTS INC.

9501 Dice Lane

Lenexa, Kansas 66215 USA

VOICE: (913) 422-0210 FAX: (913) 422-0211

www.researchconcepts.com support@researchconcepts.com

Contents subject to change

Revision History

DATE	MODIFICATION	REVISION	INITIALS
4 APR 2016	Initial Release	A	RLE

1 Introduction

The Research Concepts AIU-4 is a single speed interface box designed to interface between a Research Concepts RC2500 or RC4500, and an earth station antenna with 3-Phase AC motors. The environmental specifications for the AIU-4 is shown in Table 1. The input power and voltage ratings, as well as the output power and voltage ratings for each AIU-4 are located on a label on the inside of the enclosure door. Please adhere to all power ratings listed during installation. The mechanical dimensions and mounting information can be found in Section 2; step-by-step electrical connection instructions can be found in Section 3, and annual maintenance information can be found in Section 4. A full system schematic will be included at the end of the manual.

<i>Specification</i>	
Operational Temperature	-30°C to +50°C (14°F to 122°F)
Storage Temperature	-40°C to +60°C (-40°F to 149°F)
Ambient Humidity	95%RH or less (non-condensing)

Table 1: Environmental Specifications

2 Mechanical

2.2 Enclosure Basic Dimensions

The enclosure for the AIU-4 consists of a NEMA 4 enclosure that has a hinged door and mounting flanges on the top and bottom. Basic dimensions are provided in Figure 1.

An AIU-4 can be directly wall-mounted or mounted to a uni-strut frame with the four mounting flanges welded to the back of the housing. The mounting flanges shown in Figure 1 can accept 3/8" diameter bolts (not included).

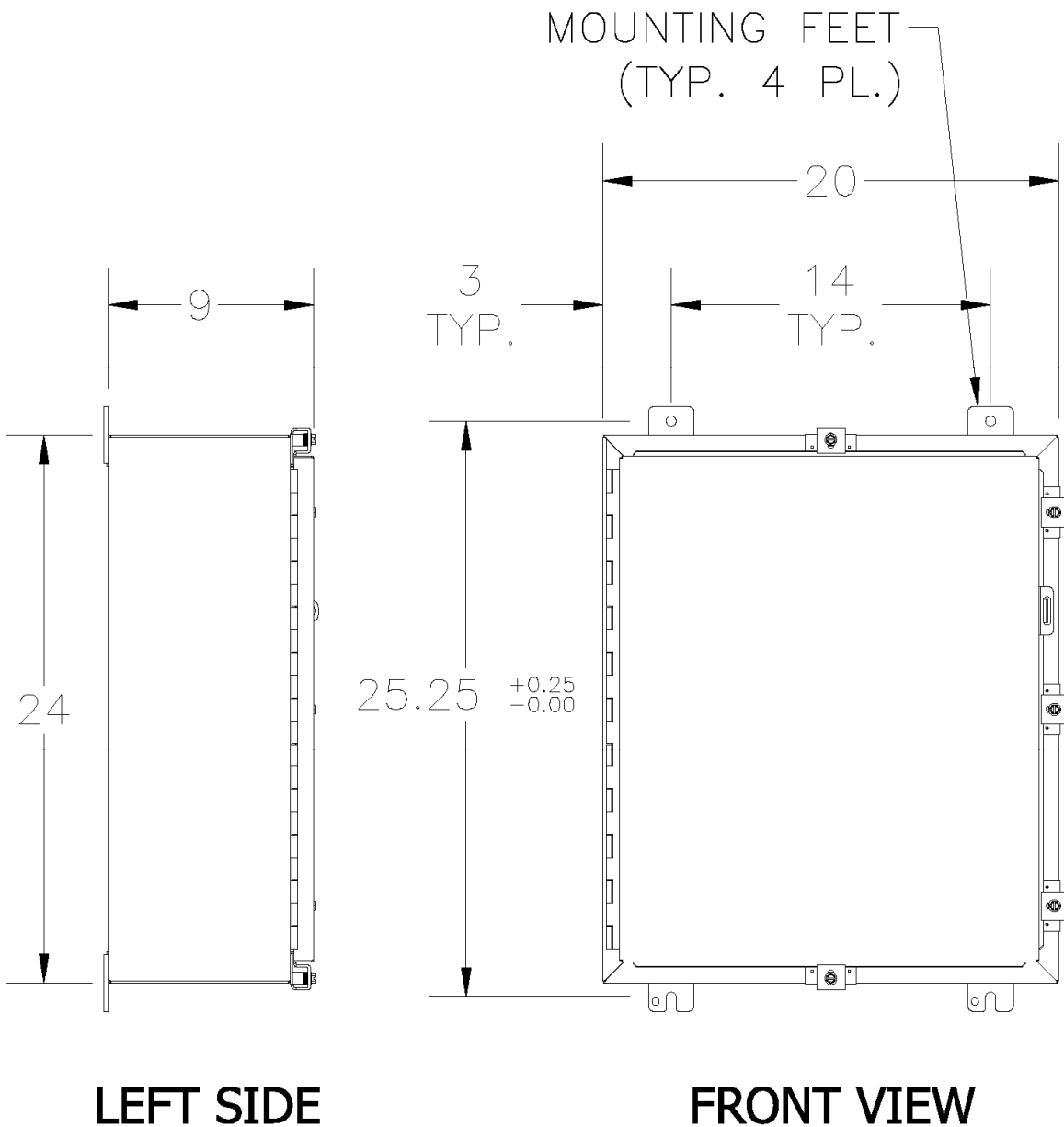

Figure 1: External Dimensions (Inches)

2.3 ACU and Antenna Cable Locations

The bottom panel of the AIU-4 is drilled to accommodate cabling to the antenna and an RC2500 or RC4500. The pattern shown in Figure 2 is the default hole pattern. Custom drill patterns, and undrilled enclosures are available upon request.

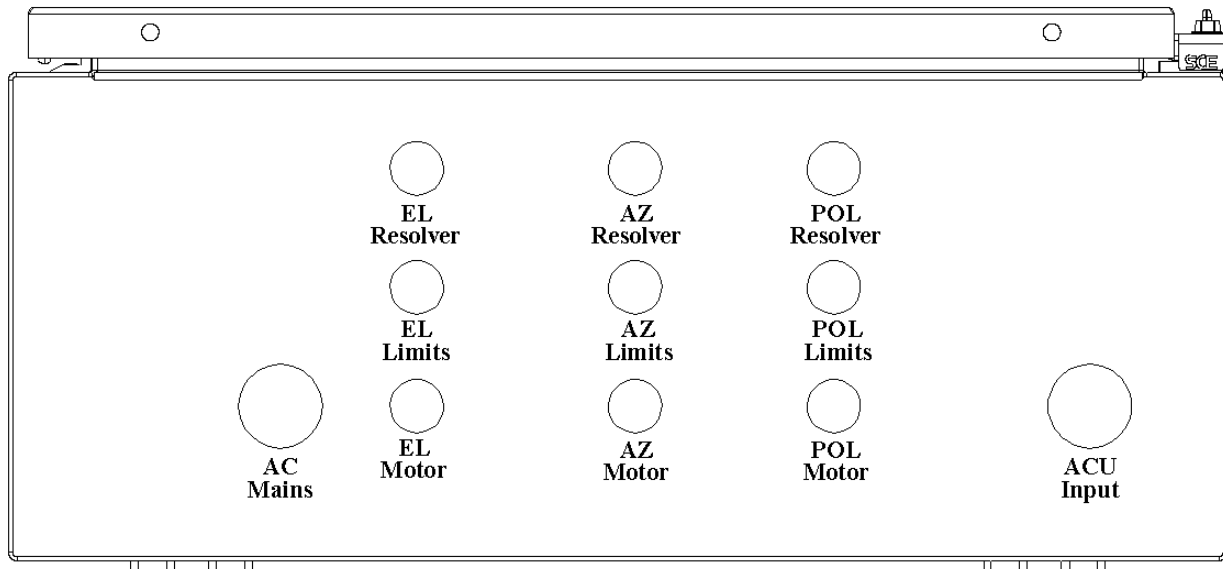

Figure 2: Standard AIU-4 Drill Pattern

The “AC Mains” and “ACU Input” holes are 1.36” diameter clearance holes for 1” NPT fittings. The remaining 9 holes are 0.886” diameter clearance holes for ½” NPT fittings. The default configuration will include plugs to seal each hole for shipment. The holes can be optionally ordered with conduit connectors or liquid tight cable glands.

3 Electrical

All components listed in the electrical wiring instructions are identified using the component identifiers shown in Figure 3. Due to variance in configurations, some components shown may not appear in your interface box. The numbering on each terminal block will progress from left to right.

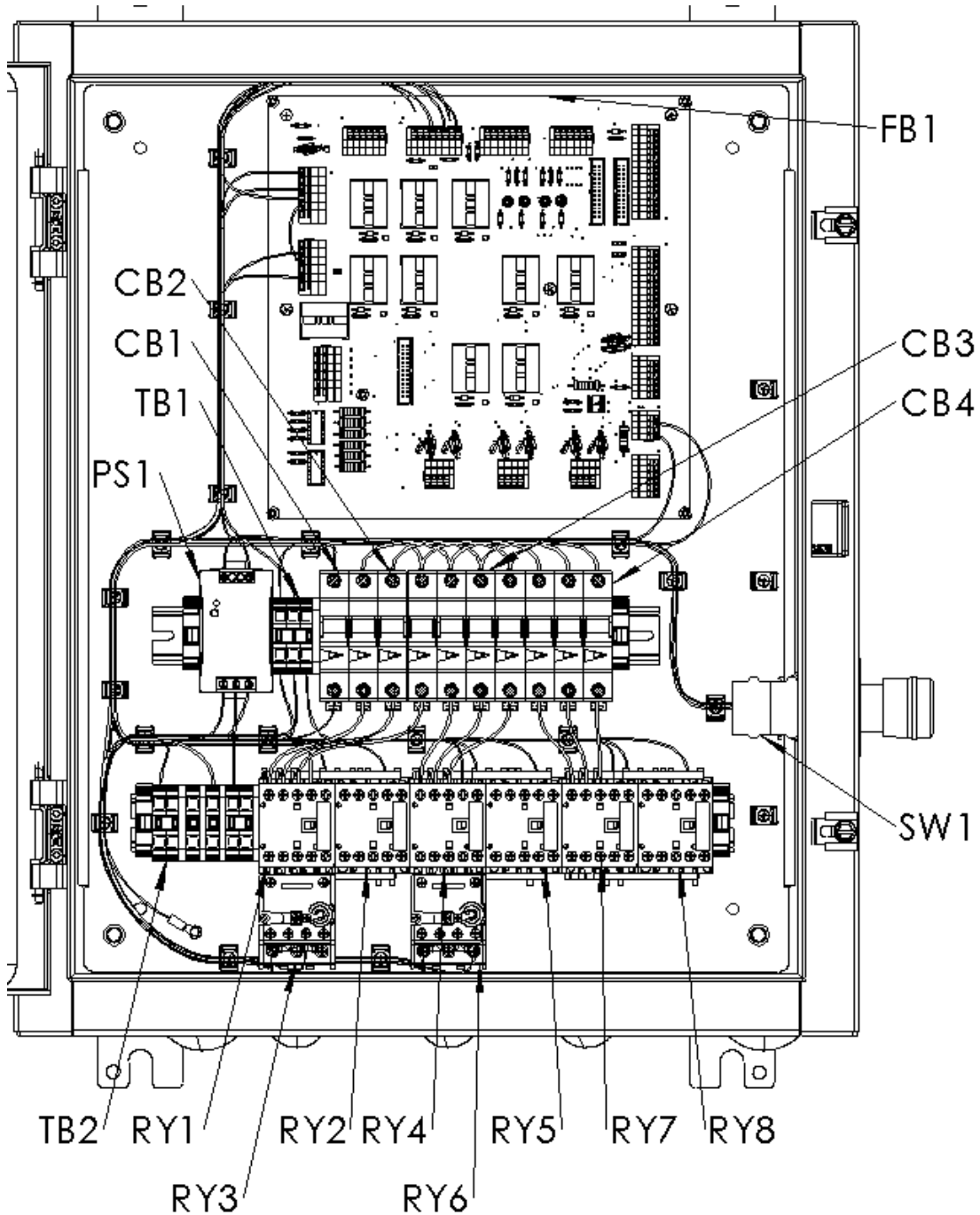

Figure 3: Component Identifiers

3.1 ACU Control Wiring

The AIU-4 requires a 25 conductor cable from the ACU to properly control and monitor the antenna. The landing location of the ACU control wiring inside the AIU-4 are shown in Figure 4. A schematic of standard wiring between an RC2500 or RC4500 and an AIU-4 is shown in Figure 5. A tabular form of the connections is shown in Table 2 and Table 3. All wire colors are based on using Belden 9937 cable. The RCI part number for this cable is CBL-25_22 and is available for order with the AIU-4. The recommended strip length for the wires landing in the AIU-4 is ¼”.

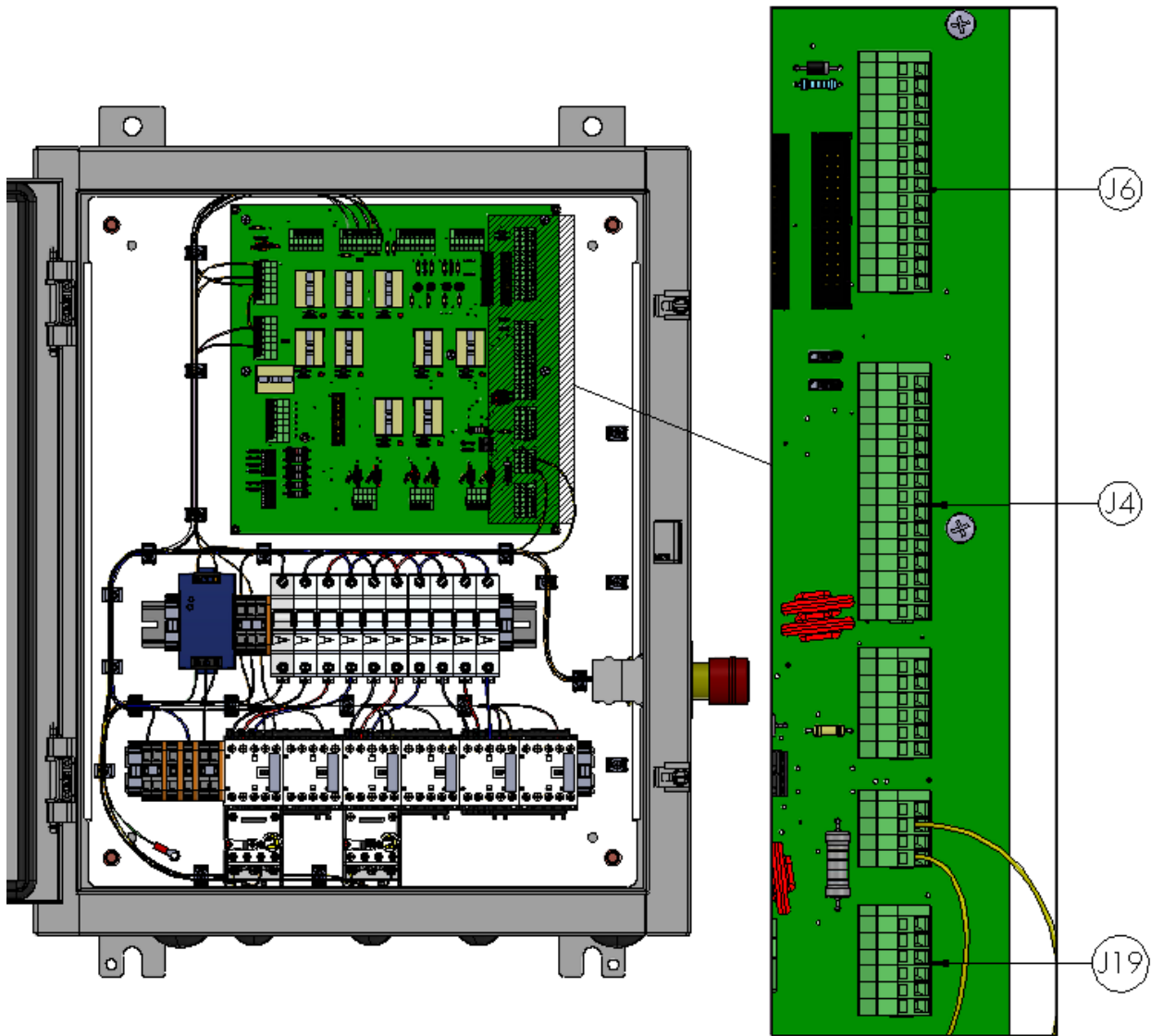

Figure 4: ACU Connection Locations

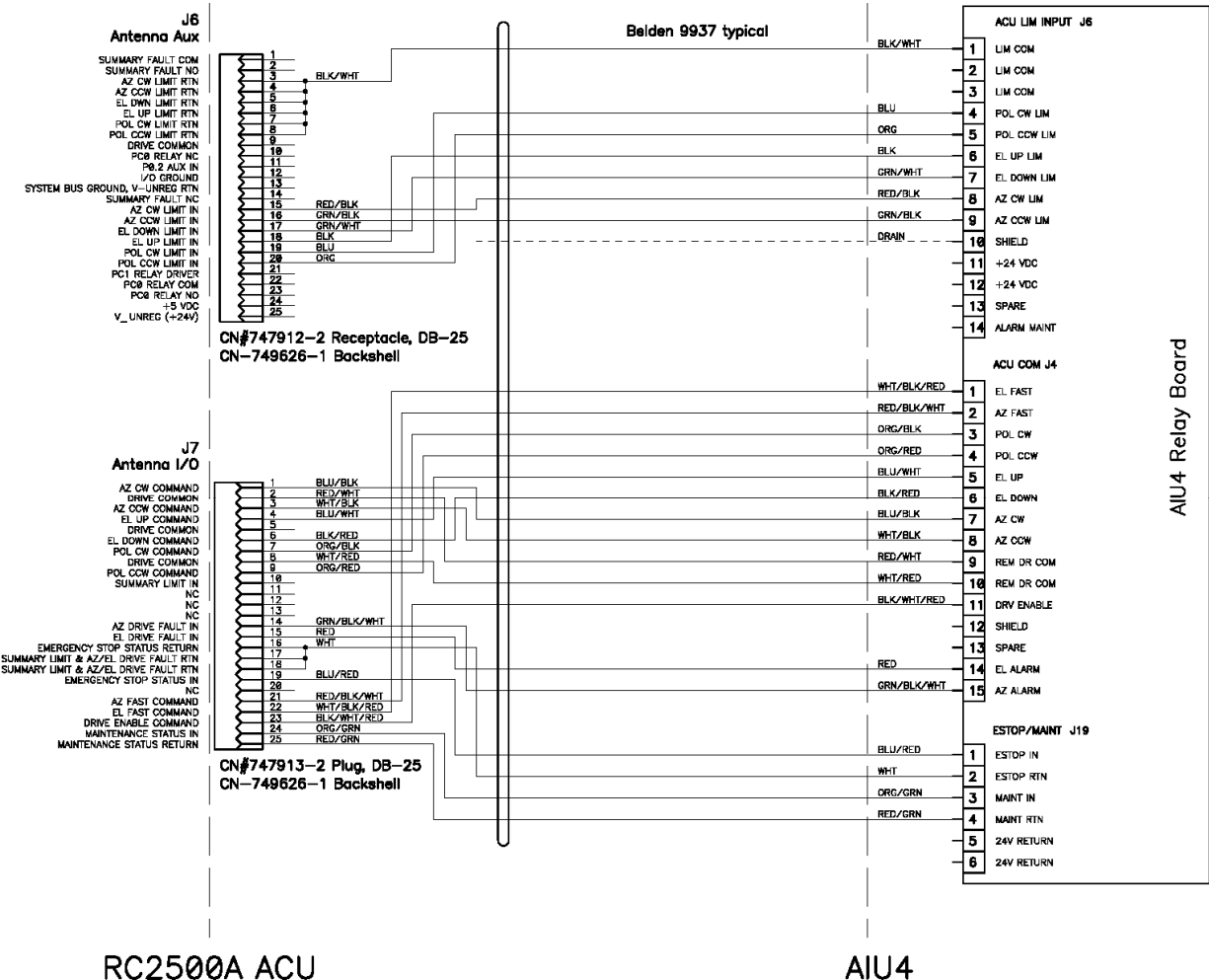

Figure 5: ACU to AIU-4 Connections

<i>Signal</i>	<i>ACU Connection Point</i>	<i>Wire Color</i>	<i>AIU4 Connection Point</i>
AZ CW Lim Rtn	J6:3	Black/White	FB1:J6:1
AZ CCW Lim Rtn	J6:4	Jumper to J6:3	NC
EL Down Lim Rtn	J6:5	Jumper to J6:4	NC
EL Up Lim Rtn	J6:6	Jumper to J6:5	NC
POL CW Lim Rtn	J6:7	Jumper to J6:6	NC
POL CCW Lim Rtn	J6:8	Jumper to J6:7	NC
AZ CW Lim In	J6:15	Red/Black	FB1:J6:8
AZ CCW Lim Rtn	J6:16	Green/Black	FB1:J6:9
EL Down Lim Rtn	J6:17	Green/White	FB1:J6:7
EL Up Lim Rtn	J6:18	Black	FB1:J6:6
POL CW Lim Rtn	J6:19	Blue	FB1:J6:4
POL CCW Lim Rtn	J6:20	Orange	FB1:J6:5
Shield	NC	Shield	FB1:J6:10

Table 2: J6 Connections

<i>Signal</i>	<i>ACU Connection Point</i>	<i>Wire Color</i>	<i>AIU4 Connection Point</i>
AZ CW Command	J7:1	Blue/Black	FB1:J4:7
Drive Common	J7:2	Red/White	FB1:J4:9
AZ CCW Command	J7:3	White/Black	FB1:J4:8
EL Up Command	J7:4	Blue/White	FB1:J4:5
EL Down Command	J7:6	Black/Red	FB1:J4:6
POL CW Command	J7:7	Orange/Black	FB1:J4:3
Drive Common	J7:8	White/Red	FB1:J4:10
POL CCW Command	J7:9	Orange/Red	FB1:J4:4
AZ Drive Fault In	J7:14	Green/Black/White	FB1:J4:15
EL Drive Fault In	J7:15	Red	FB1:J4:14
E-Stop Status Rtn	J7:16	White	FB1:J19:2
AZ/EL Drive Fault Rtn	J7:17	Jumper to J7:16	NC
AZ/EL Drive Fault Rtn	J7:18	Jumper to J7:17	NC
E-Stop Status In	J7:19	Blue/Red	FB1:J19:1
AZ Fast Command	J7:21	Red/Black/White	FB1:J4:2
EL Fast Command	J7:22	White/Black/Red	FB1:J4:1
Drive Enable	J7:23	Black/White/Red	FB1:J4:11
Maintenance Status In	J7:24	Orange/Green	FB1:J19:3
Maintenance Status Rtn	J7:25	Red/Green	FB1:J19:4

Table 3: J7 Connections

3.2 Limit Switch Wiring

The AIU-4 requires 1 normally closed contact at each limit for Azimuth, Elevation and Polarization. The landing location of the limit switch wires inside of the AIU-4 are shown in Figure 6. A schematic of standard wiring between the limit switches and AIU-4 is shown in Figure 7. All wire colors are based on using Alpha 2404C cable. The RCI part number for this cable is CBL-4_22SHLDUV and is available for order with the AIU-4. The recommended strip length for the wires landing in the AIU-4 is ¼”.

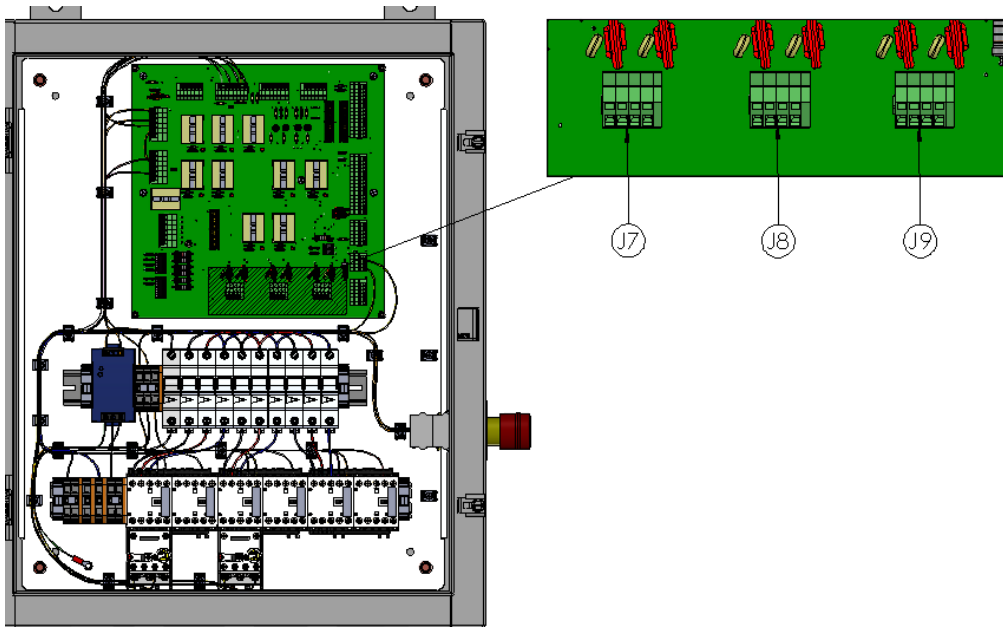

Figure 6: Limit Switch Locations

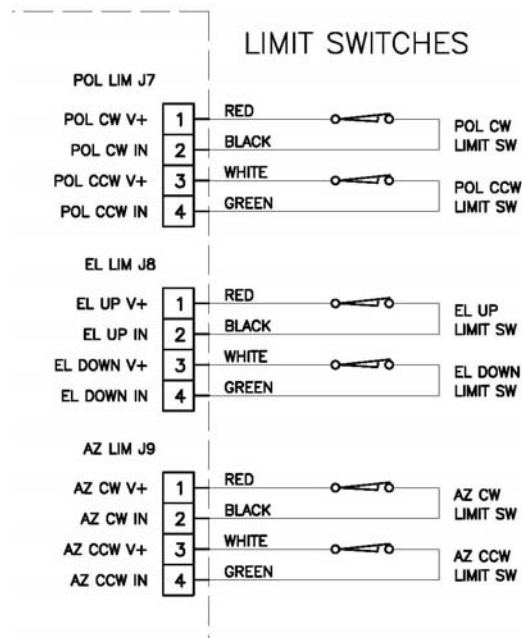

Figure 7: Limit Switch Connections

3.3 Elevation and Azimuth Motor Wiring

The AIU-4 is designed to drive 3 phase AC motors for Elevation and Azimuth. The AIU-4 will be configured for the proper voltage and power of each motor when ordered. The landing location of the motor wires inside of the AIU-4 are shown in Figure 8.

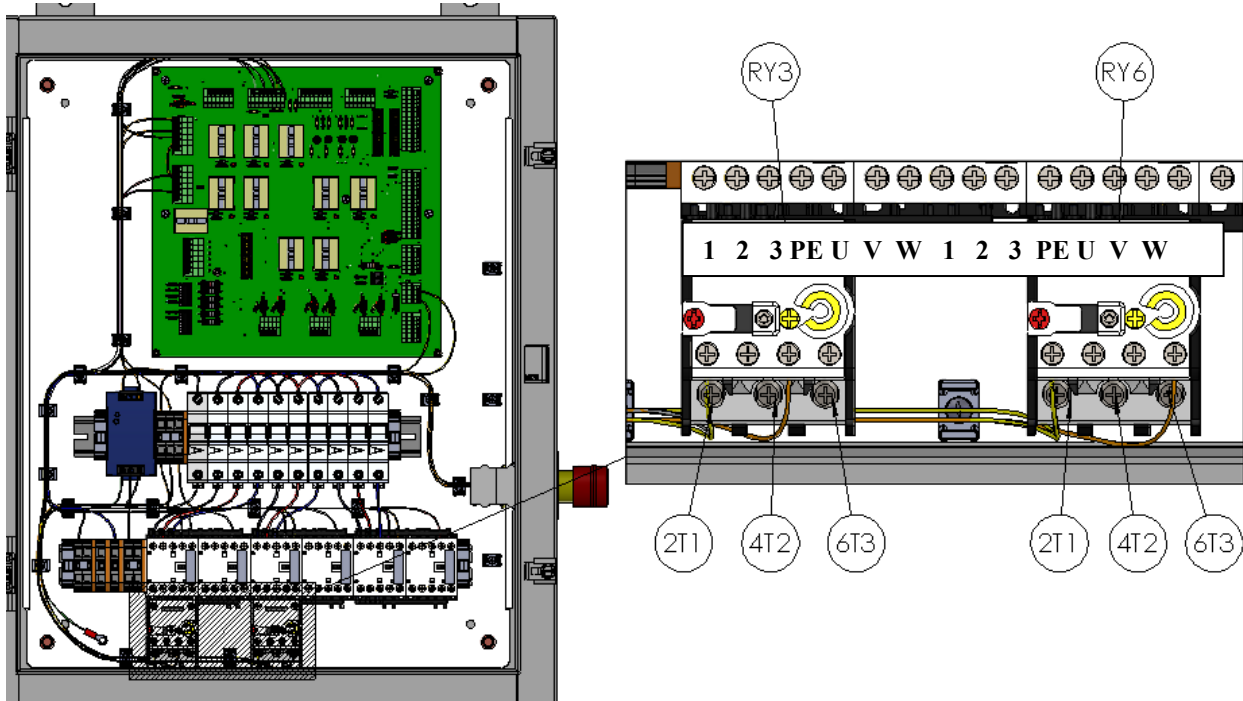

Figure 8: Elevation and Azimuth Motor Wire Locations

Table 4 shows the connections for the Elevation motor and Table 5 shows the connections for the Azimuth motor.

<i>Signal</i>	<i>Terminal</i>
Phase 1 (U,T1)	RY3:2T1
Phase 2 (V,T2)	RY3:4T2
Phase 3 (W,T3)	RY3:6T3
Motor Ground	Ground Stud

Table 4: Elevation Motor Wires

<i>Signal</i>	<i>Terminal</i>
Phase 1 (U,T1)	RY6:2T1
Phase 2 (V,T2)	RY6:4T2
Phase 3 (W,T3)	RY6:6T3
Motor Ground	Ground Stud

Table 5: Azimuth Motor Wires

3.4 Polarization Motor Wiring

The AIU-4 can be configured to work with a wide range a polarization motors. The AIU-4 will be properly configured for the antenna Polarization motor specified by the customer. Figure 9 shows the landing location of the Polarization motor wires. For detailed connection information, please consult the schematic that was included with the AIU-4.

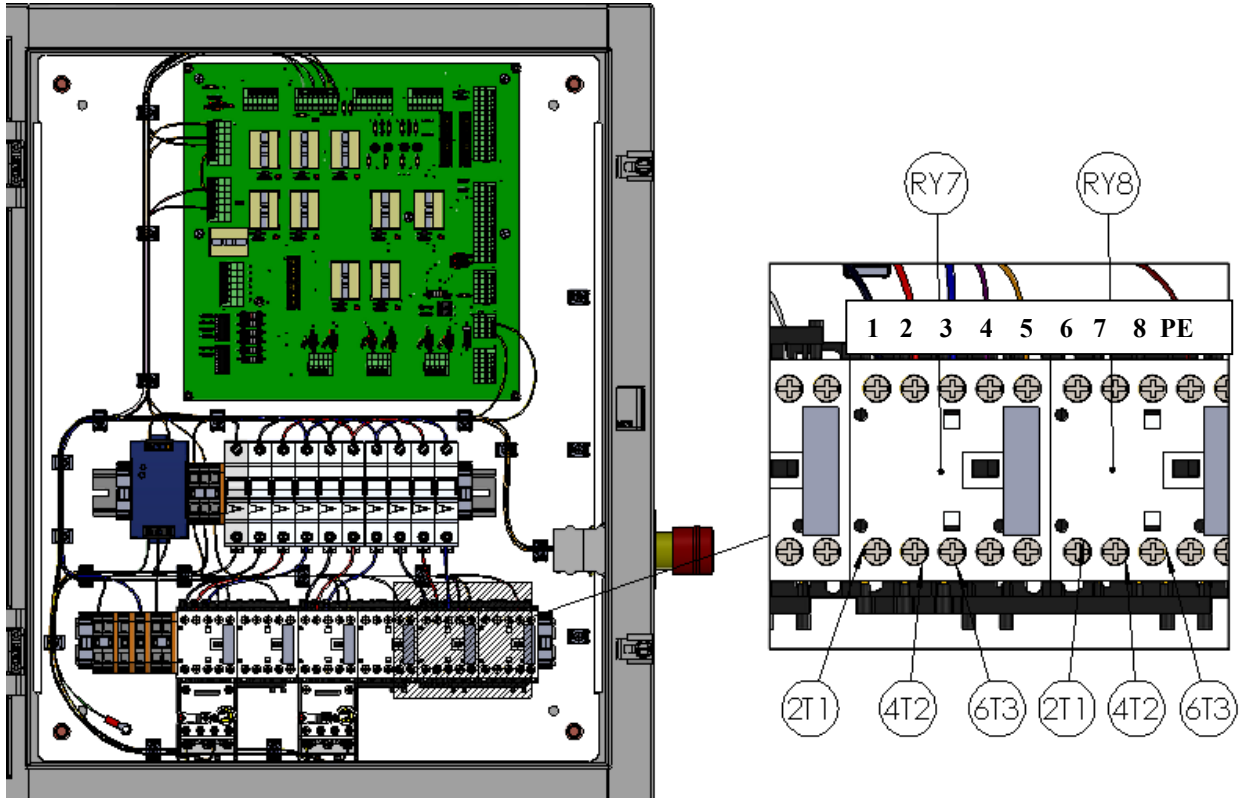

Figure 9: Polarization Motor Wire Location

3.5 Elevation and Azimuth Brake Wiring

If specified during the ordering process, the AIU-4 will come equipped with the proper hardware to actuate brakes for Elevation and Azimuth. The landing locations for the Elevation brake (RY9) and Azimuth brake (RY7) are shown in Figure 10. The AIU-4 can be configured for single phase brake options. Please consult the schematic included with the AIU-4 for detailed information on how to properly wire the brakes.

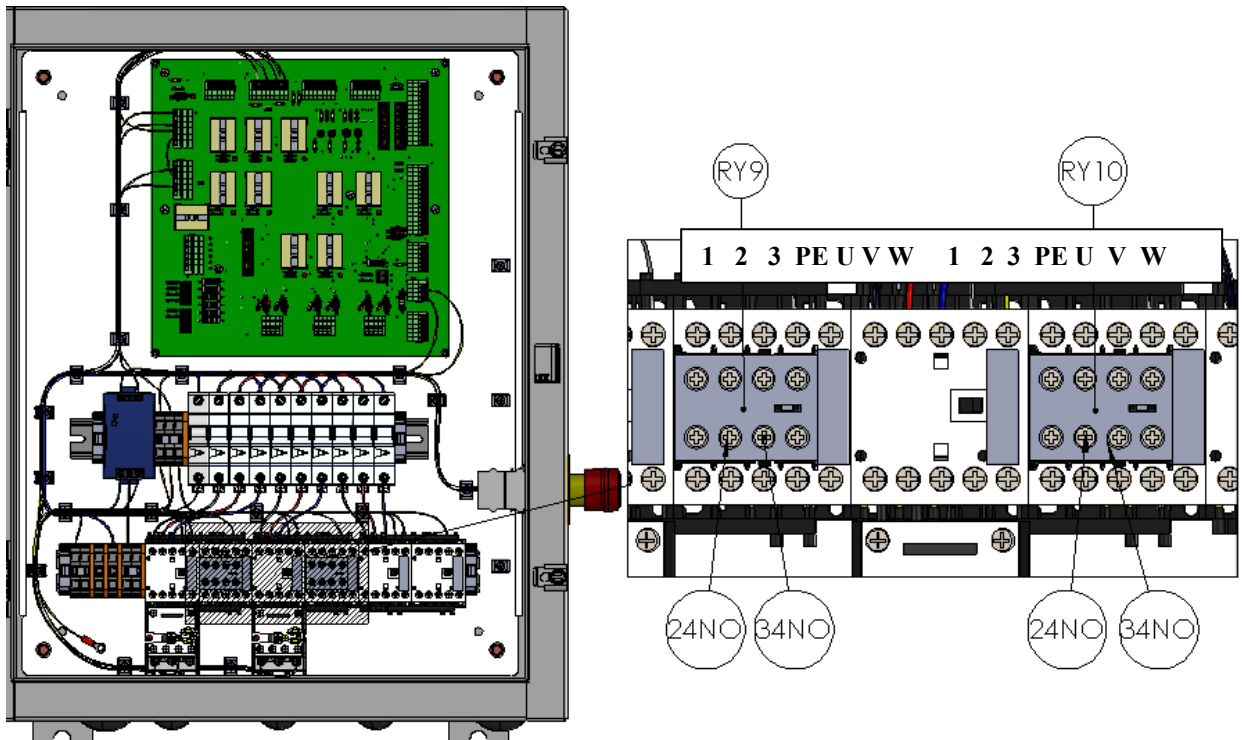

Figure 10: Elevation and Azimuth Brake Locations

3.6 AC Input Wiring

The AIU-4 is setup to operate using a 3 phase AC input, with a neutral and potential earth connection. The AIU-4 will be configured to operate with the proper voltage specified during ordering. The landing location of the AC input power is shown in Figure 11. Table 6 shows the connections for the AC input wiring.

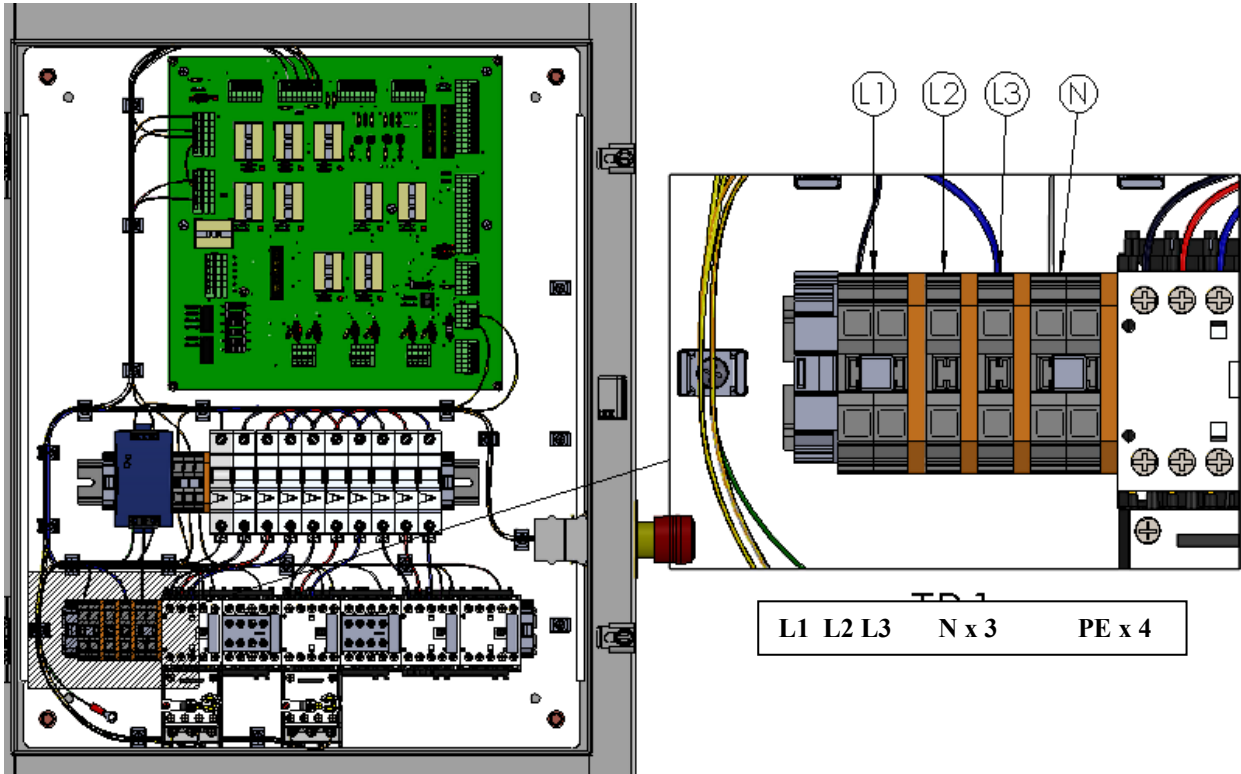

Figure 11: AC Input Wiring

<i>Signal</i>	<i>Terminal</i>
Phase 1 (L1)	TB2:L1
Phase 2 (L2)	TB2:L2
Phase 3 (L3)	TB2:L3
Neutral	TB2:N
Potential Earth	Ground Stud

Table 6: AC Input Wires

3.7 Resolver Connections

The resolvers that are used for position feedback are wired directly to the controller. For information on how to connect the resolvers to the controller see section 3.3.1.3 of the RC2500 manual.

4 Local Control

Each AIU-4 will come with a local control panel that needs to be installed prior to using the AIU. The panel will be attached to 5 points above the relay board as shown in Figure 12. Prior to attaching the switch panel, connect the included ribbon cable from the switch panel to the relay board. The red wire on the ribbon cable will be on the same side as label J3 on the relay board and label J1 on the switch board. Five stainless steel screws will be included with the panel for installation.

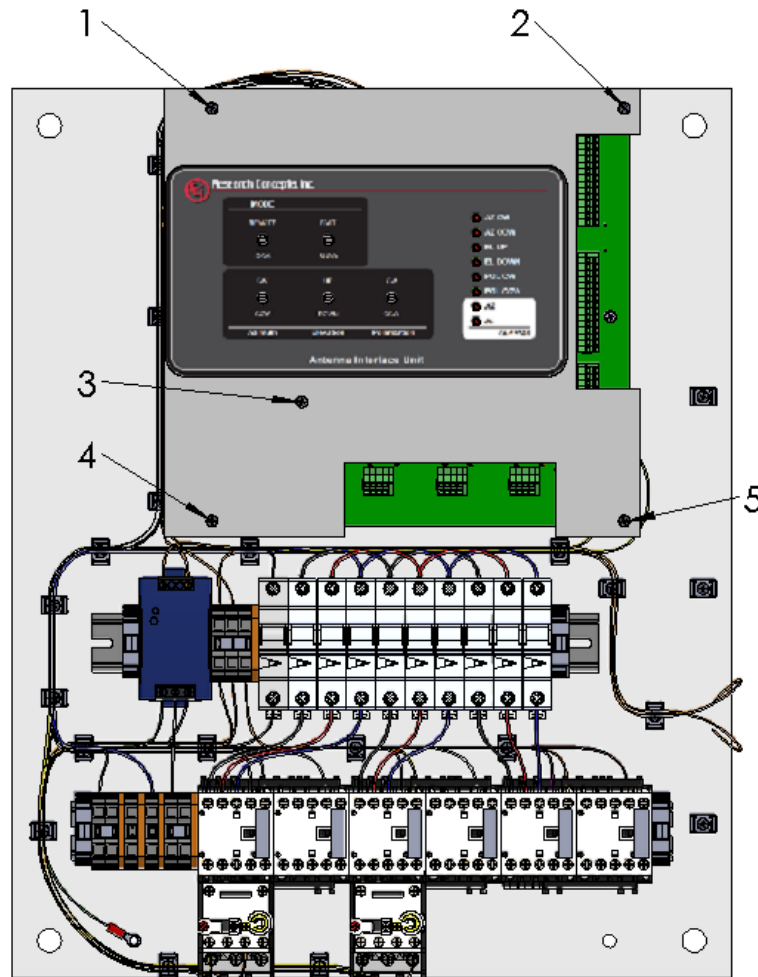

Figure 12: Switch Panel Installation

This panel can be used to control the antenna during initial setup and maintenance. This panel is shown in Figure 13 and a description of the switch functions and LED functions are detailed in Table 7 and Table 8 respectively.

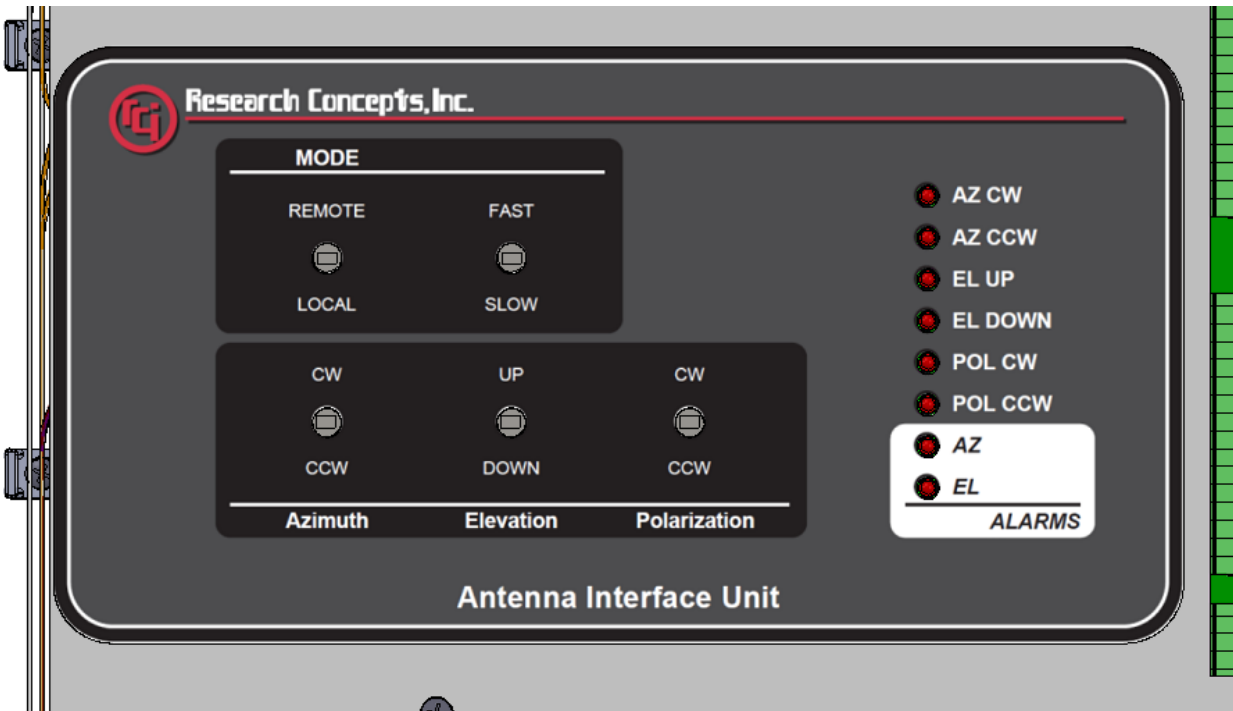

Figure 13: Local Control Panel

REMOTE/LOCAL	REMOTE	Sets the AIU4 to REMOTE mode. None of the other local controls will be active while in REMOTE mode. The AIU4 is controlled only via the RC2500 Antenna Control Unit.
	LOCAL	Sets the AIU4 to LOCAL mode. All other local controls are active and the Antenna Control Unit cannot command movements of the antenna. The Antenna Control Unit will display "MAINTENANCE MODE" when the AIU4 is in LOCAL mode.
FAST/SLOW	FAST	Azimuth and Elevation motor speed set to FAST.
	SLOW	Azimuth and Elevation motor speed set to SLOW.
Azimuth	CW	Command Azimuth CW movement.
	CCW	Command Azimuth CCW movement.
Elevation	UP	Command Elevation UP movement.
	DOWN	Command Elevation DOWN movement.
Polarization	CW	Command Polarization CW movement
	CCW	Command Polarization CCW movement.

Table 7: Local Switch Functions

AZ CW	Indicates the Azimuth CW limit switch is activated.
AZ CCW	Indicates the Azimuth CCW limit switch is activated.
EL UP	Indicates the Elevation UP limit switch is activated.
EL DOWN	Indicates the Elevation DOWN limit switch is activated.
POL CW	Indicates the Polarization CW limit switch is activated.
POL CCW	Indicates the Polarization CCW limit switch is activated.
AZ (ALARM)	Indicates an Azimuth Drive Alarm from the Azimuth overload relay.
EL (ALARM)	Indicates an Elevation Drive Alarm from the Elevation overload relay.

Table 8: Led Functions

5 Annual Maintenance

- Inspect the inside of the enclosure for dirt and signs of water ingress.
- Inspect all wires and components for signs of excessive heat.
- Ensure that all liquid tight cable clamps or conduit connections are tightened correctly.
- If desiccant is used, replace the bag/canister.

6 Service

Refer to the schematic supplied with the AIU-4 for part numbers of each component. For technical support or to purchase replacement components, contact Research Concepts using the phone number between the hours of 8AM and 5PM Central Time Monday through Friday. For help outside of normal business hours, please e-mail support@researchconcepts.com and a technician will respond as they become available.

7 Warranty Statement

Research Concepts, Inc.(RCI) warrants to the original purchaser, this product shall be free from defects in material and workmanship for one year, unless expressed otherwise, from the date of the original purchase.

During the warranty period, RCI will provide, free of charge, both parts and labor necessary to correct such defects.

To obtain such a warranty service, the original purchaser must:

- 1) Notify RCI as soon as possible after discovery of a possible defect, of:
 - a) the model and serial number
 - b) identify the date of purchase
 - c) Provide a detailed description of the problem, including details on the electrical connection to associated equipment and list of such equipment, and circumstances when problem arose.
- 2) If shipment to RCI is required, a Return Material Authorization number (RMA#) is required prior to shipment.
- 3) Deliver the product to RCI, or ship the same in its original container or equivalent, fully insured and shipping charges prepaid. Any duties and taxes incurred will the responsibility of the original purchaser. For assistance on international shipping, please contact RCI.
- 4) After repair, RCI will provide ground shipping to any location in the continuous 48 US states. Express shipping and shipping outside of the continuous 48 US states will be the responsibility of the customer.

Correct maintenance, repair, and use are important to obtain proper performance from this product. Therefore, read the instruction manual carefully and completely. This warranty does not apply to any defect that RCI determines is due to:

- Improper maintenance or repair, including the installation of parts or accessories that do not conform to the quality and specifications of the original parts.
- Misuse, abuse, neglect, or improper installation including disregard for installation of backup or safety override equipment.
- Accidental or intentional damage.
- Lightning or acts of God.

There are no additional implied warranties.

The foregoing constitutes RCI's entire obligation with respect to this product, and the original purchaser and any user or owner shall have no other remedy and no claim for incidental or consequential damages. Some states do not allow limitations or exclusions of incidental or consequential damages, so the above limitation and exclusion may not apply to you. This warranty gives you specific legal rights and you may also have other rights which may vary from state to state.

RCI retains the right to make changes to these specifications any time, without notice.

Copyright – Research Concepts Inc., 2016

8 AIU-4 Configuration Worksheet

Input Voltage

What is the site voltage? _____

How many phases? _____

Is there a separate Neutral? (Yes/No) _____

Is there a separate Ground? (Yes/No) _____

Elevation Motor

What is the motor voltage? _____

How many phases? _____

What is the power rating? (HP or kW) _____

Does the motor require brakes? (Yes/No) _____

If Yes:

What is the voltage for the brakes? _____

If AC Voltage, how many phases? _____

What is the current required? _____

Azimuth Motor

What is the motor voltage? _____

What is the power rating? (HP or kW) _____

Does the motor require brakes? (Yes/No) _____

If Yes:

What is the voltage for the brakes? _____

If AC Voltage, how many phases? _____

What is the current required? _____

Polarization Motor

Does the antenna have a Polarization Motor? (Yes/No) _____

If Yes:

What is the voltage? _____

AC or DC? _____

For AC motors, how many phases? _____

What is the maximum current draw? _____

Are starting components required? (Yes/No) _____

If Yes:

What are the values and/or part numbers of the components?
