

APPENDIX B - MOUNT SPECIFIC DATA

For the AVL 3.8m SNG Antenna System

Revision: 30 September 2010, Software Version 1.60

1.1 Appendix B Organization

This appendix is provided as a supplement to the baseline RC3000 User's Manual. The corresponding paragraphs in the baseline RC3000 manual are referred to when data specific to the referenced mount is described.

1.2 Mount Model

This appendix describes the RC3000 antenna controller unit variation built for use by the AVL 3.8m SNG antenna. This mount model type is designated as "U2".

1.3.2 System Interface Requirements

The U2 ACU follows the standard RC3000 interface requirements with the following modifications:

- the RC3000 ACU is contained in an "embedded" weatherproof enclosure rather than the standard rack-mounted enclosure
- rather than driving azimuth and elevation motors directly, the U2 ACU links to an Antenna Interface Unit (AIU). The AIU will receive control signals from the ACU and provide greater drive capability than available from a standard rack-mounted RC3000 ACU alone. The AIU itself is housed in a weatherproof enclosure.
- The AIU provides DC power to the ACU.
- The AIU also signals the ACU if an elevation over temperature situation exists.
- No front panel (LCD & keypad) exists for this variation of the RC3000 ACU. Front Panel control is mechanized by remote control either via an Ethernet interface. See appendix IP for description of the Ethernet interface.
- Instead of the baseline GPS receiver unit, an embedded GPS receiver with a separate smaller antenna is used.
- Interfaces are mechanized by waterproof connectors detailed in subsequent paragraphs of this appendix.

2.0 INSTALLATION

2.1.1 RC3000 Antenna Controller

For the U2 mount, the ACU is mechanized as an "embedded" controller. Rather than being a rack-mounted unit, the U2 ACU is contained in a weatherproof enclosure.

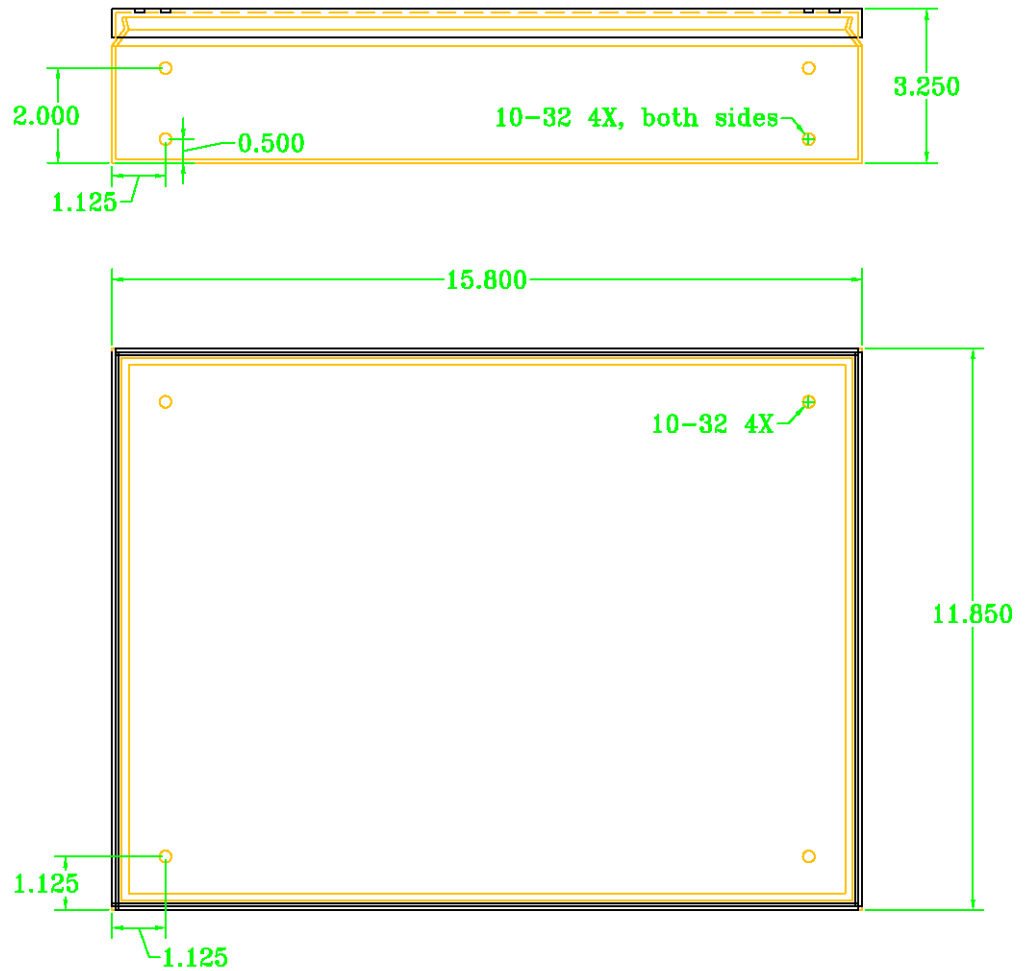

2.1.2 GPS

The U2 controller uses an embedded GPS receiver which externally interfaces to a small GPS antenna via a TNC connector.

2.1.4 Inclinometer Orientation

The inclinometer should be rigged with the face of the reflector vertical.

2.2 Electrical Connections

The following diagrams depict the location of weatherproof connectors that are mounted at either end of the embedded enclosure.

Back

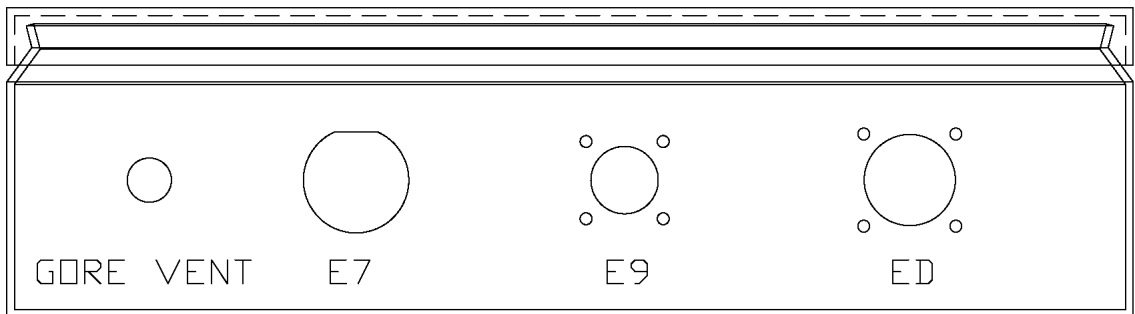
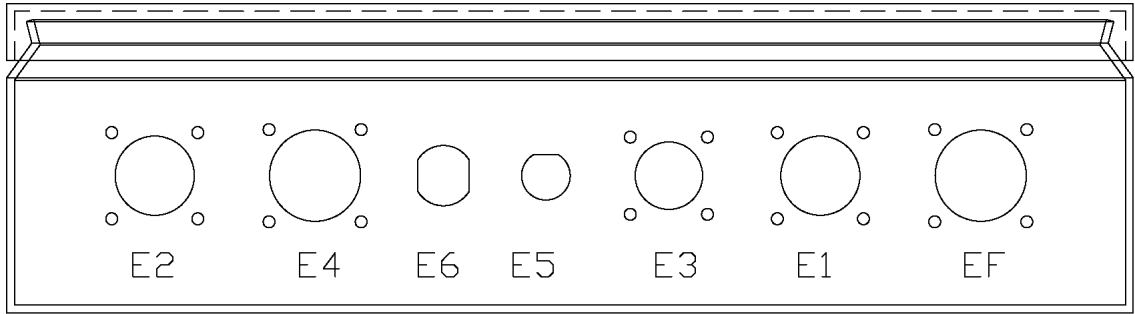

Front

2.2.1-.13 Connection Schedule

The interfaces described in sections 2.2.1 through 2.2.13 of the baseline manual are implemented through connectors E1 to EF on the embedded controller. To accommodate more efficient cabling, interfaces have been reallocated per the following schedule.

U2 connector	Description	Baseline Manual Reference / Comments
E1	Az/EI Pulses	2.2.10
E2	Az/EI Sensors	2.2.3, 2.2.4,
E3	Pol Motors & Sensors	2.2.2, 2.2.3, 2.2.4
E4	Antenna Accessories & Compass	2.2.7
E5	GPS Antenna	TNC connector
E6	RF In / LNB Power	F connector
E7	Ethernet	RJ45 connector
E9	Modem Accessories	
ED	Handheld Controller	
EF	ACU to AIU Link	

The following diagrams detail the pinouts of various connectors. The major polarizing notch is considered to be the top of each connector. All pins are shown from a front view of each connector.

Reference	EI	
Description	Az/EI Encoders	
RCI P/N	CN-MS31221419P	
Manufacturer	Amphenol Industrial	
Manufacturer P/N	MS3122E-14-19P	

Pin	Description	Notes
A		
B		
C	Az Encoder Ch A	
D	Az Encoder Ch B	
E	Az Encoder Gnd	
F	EI Encoder Gnd	
G		
H		
J		
K		
L		
M		
N	EI Encoder Ch A	
P	Encoder Shields	
R	Az Motor Shield	
S	Az Encoder +V	
T	EI Encoder +V	
U	EI Encoder Ch B	
V	EI Motor Shield	

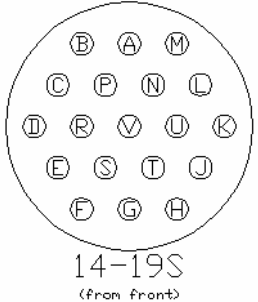
Reference	E2	 <p>14-19S (from front)</p>
Description	Az/EI Position Sensors & Limits	
RCI P/N	CN-MS31221419S	
Manufacturer	Amphenol Industrial	
Manufacturer P/N	MS3122E-14-19S	

Pin	Description	Notes
A		
B	Inclinometer -V	Not required for ratiometric
C	Inclinometer Gnd	
D	Inclinometer Signal	
E		
F	Inclinometer Shield	
G	Az Pot + (CW)	
H	Az Pot Wiper	
J	Az Pot - (CCW)	
K	Az Pot Shield	
L	EI Up Limit +V	
M	EI Up Limit In	
N	EI Down Limit +V	
P	EI Down Limit In	
R	EI Stow Limit +V	EI Down Disable +V (VN)
S	EI Stow Limit In	EI Down Disable In (VN)
T	Az Stow Limit +V	
U	Az Stow Limit In	
V	Inclinometer +V	+5v for ratiometric

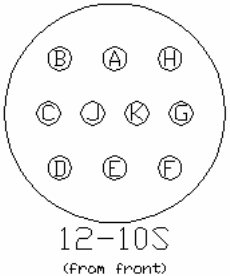
Reference	E3	 <p>12-10S (from front)</p>
Description	Pol Motor, Sensors, & Limits	
RCI P/N	CN-MS31221210S	
Manufacturer	Amphenol Industrial	
Manufacturer P/N	MS3122E-12-10S	

Pin	Description	Notes
A	Pol Motor +	
B	Pol Motor -	
C	Pol Motor Shield	
D	Pol Pot - (CCW)	As of Rev 2
E	Pol Pot Wiper	
F	Pol Pot + (CW)	As of Rev 2
G	Pol Pot Shield	
H	Pol CW Limit In	
J	Pol CCW Limit In	
K	Pol Limits +V	

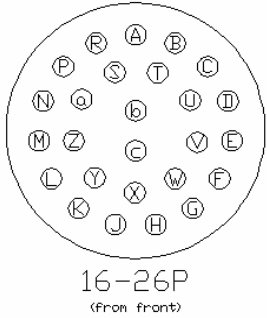
Reference	E4	
Description	Compass, Accessories	
RCI P/N	CN-MS31221626P	
Manufacturer	Amphenol Industrial	
Manufacturer P/N	MS3122E-16-26P	

Pin	Description	Notes
A	Compass +V	
B	Compass Gnd	
C	Compass RS232 In	
D	Compass RS232 Out	
E	Az CW Limit In	
F	Az CCW Limit In	
G	Pol ID Bit D In	
H	Pol ID Bit E In	
J	Pol ID Bit F In	
K	Pol ID Bit J In	
L	Pol ID Bit R In	
M		
N		
P		
R		
S		
T	Compass Shield	
U	Compass Signal	
V	Az Limits +V	
W	Pol ID Bits +V	
X		
Y		
Z		
a		
b		
c		

Reference	E5
Description	GPS Antenna, 50-Ohm TNC
RCI P/N	CN-122192
Manufacturer	Amphenol RF
Manufacturer P/N	122192

Pin	Description	Notes
1	Center Conductor	
2	Shield	

Reference	E6
Description	RF Input, 50 Ohm N-Type
RCI P/N	CN-172129
Manufacturer	Amphenol RF
Manufacturer P/N	172129

Pin	Description	Notes
1	Center Conductor	
2	Shield	

Reference	E7
Description	Ethernet Interface
RCI P/N	CN-1738601-1
Manufacturer	Tyco Electronics
Manufacturer P/N	1738601-1

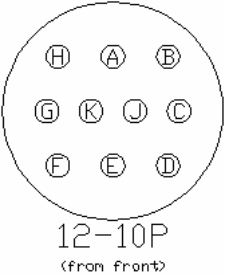
Reference	E9	
Description	Modem Interface	
RCI P/N	CN-MS31221210P	
Manufacturer	Amphenol Industrial	
Manufacturer P/N	MS3122E-12-10P	

Pin	Description	Notes
A	+5v	Max 150 mA
B	AGC Lock In	
C	AGC Signal In	
D	AGC Common	
E	AGC Offset Out	
F	HPA Contacts NO	
G	HPA Contacts NC	
H	HPA Contacts Common	
J	GPS Gnd	
K	GPS RS232 Loopout	

Reference	ED
Description	RC3000 Hand-Held Remote Control
RCI P/N	CN-MS31221626P
Manufacturer	Amphenol Industrial
Manufacturer P/N	MS3122E-16-26P or Souriau UT0W01626P
Mating Connector	MS3116F16-26S or Souriau UT0W61626S RCI p/n CN-UT0W61626S

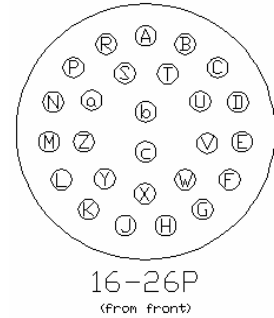

Pin	Description	Notes
A	POL CW Lim LED	3KAN5_J9:1
B	POL CCW Lim LED	3KAN5_J9:3
C	EL Down Lim LED	3KAN5_J9:5
D	EL Up Lim LED	3KAN5_J9:7
E	AZ CCW Lim LED	3KAN5_J9:9
F	AZ CW Lim LED	3KAN5_J9:11
G	EL STOW Lim LED	3KAN5_J9:13
H	AZ STOW Lim LED	3KAN5_J9:15
J	Gnd	3KAN5_J9:17
K	Gnd	3KAN5_J9:19
L	Gnd	3KAN5_J9:11
M	Gnd	3KAN5_J9:23
N	Nc	
P	Nc	
R	Nc	
S	/POL MOVE	3KAN5_J9:6
T	/FAST	3KAN5_J9:8
U	/COMP	3KAN5_J9:10
V	DIR /CW	3KAN5_J9:12
W	AZ_/EL_SEL	3KAN5_J9:14
X	AZ_/EL_MOVE	3KAN5_J9:16
Y	+5V	3KAN5_J9:18
Z	+5V	3KAN5_J9:20
a	+5V	3KAN5_J9:22
b	+5V	3KAN5_J9:24
c	Nc	

Reference EF
Description ACU to AIU Link
RCI P/N CN-MS31221626S
Manufacturer Amphenol Industrial
Manufacturer P/N MS3122E-16-26S or Souriau UT0W01626S
Mating Connector MS3116F16-26P or Souriau UT0W61626P
 RCI p/n CN-UT0W61626P

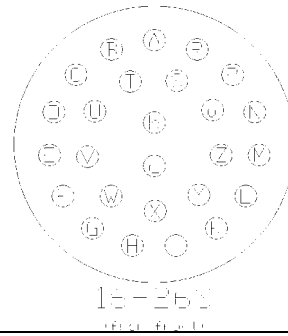

Pin	Description	Notes
A	AZ_DRV	Az Motor +; FC-3KMDC_J11:7
B	AZ_RTN	Az Motor -; FC-3KMDC_J11:8
C		
D	+24VDC	ACU source from AIU
E	+24VDC	ACU source from AIU
F	EL_MTR_OT1	EL Overtemp, NC open at Hot; 3KAN5_J5:21;12V
G	EL_MTR_OT2	EL Overtemp, NC open at Hot; 3KAN5_J5:22;input
H		
J	SAFETY	24V_BRK_EL; 3KMDC_J12:2
K		
L		
M		
N		
P	EL_DRV	EI Motor +; FC-3KMDC_J11:1
R		
S		
T	EL_RTN	EI Motor -; FC-3KMDC_J11:2
U		
V		
W		
X		
Y	FAST_/SLOW	24V_BRK_AZ; 3KMDC_J12:1
Z	GND	ACU Source from AIU
a	GND	ACU Source from AIU
b		
c		

2.3.2 Elevation Calibration

Elevation Reference Position

From the reflector vertical position, the elevation reference voltage should be close to 1.69 V. The elevation displayed at this voltage will be 22.6 reflecting the mount's RF offset.

3.0 Detailed Operation

The U2 version of the RC3000 operates as described in the baseline RC3000 User's Manual with a few modifications as noted below.

3.1.2 Keypad Operation

Since no actual keypad exists for the U2 version, user inputs must be made via a "Remote Front Panel" application implemented either via the serial or Ethernet remote interfaces.

3.2.2.3.3 Azimuth Scanning Autopeak

A unique scanning scheme is implemented for this mount that allows the LOCATE mode to initially look for a beacon signal on the SS2 channel and then also look for a modem signal on SS1.

To enable this "voting" scheme, the following configuration items must be programmed exactly:

- AUTOPEAK SIG must be set to "3" to get an initial scan for SS2 (beacon receiver)
- AUTOPEAK ON must be set to "2" to get a peakup done after scanning
- a PRESET SAT must be programmed with correct beacon frequencies (see app BCN)
- NOTE: confirm SS2 LOCK is set to 2 to match beacon receiver lock polarity

With these conditions set, a scan will begin like normal looking for the programmed beacon.

If the beacon signal is found, a peakup on that signal will be performed. Following the peakup, a check of SS1 signal strength will be performed. If SS1 is above the SS1 TH(reshold) value, the LOCATE will finish normally and end by moving to MANUAL mode. If SS1 is not above SS1 TH, the message **"!BCN FOUND BUT NO MODEM LOCK! <MODE>EXIT"** will be displayed until the user presses the MODE key.

If a beacon signal is not found, the message **"** NO BEACON FOUND - SCAN FOR MODEM **"** will be displayed for two seconds then an additional scan for SS1 signal will be initiated. If this scan finds a SS1 signal above the SS1 TH value, a peakup will be performed and the LOCATE will end in MANUAL mode as normal. If this scan finds no SS1 above the threshold value the normal LOCATE message **"*** NO PEAK FOUND *** <MODE>EXIT"** will be displayed to indicate the LOCATE scan has been unsuccessful.

3.2.2.8 Settings

When a drive overtemperature alarm condition exists (see 3.4), the additional message " <5>RESET OVERTEMP" appears on line 2 of the SETTINGS mode screen. Pressing the 5 key will reset the alarm condition until the condition appears again.

3.4 Alarm Displays

* DRIVE OVERTEMP - RESET VIA SETTINGS *

This alarm will be triggered anytime a drive overtemperature condition is signaled by the AIW. When triggered, this alarm will not allow further movement until it has been cleared by the user as described in the SETTINGS mode. If the AIU is still signaling the condition, the alarm will reappear soon after being cleared.

3.3.1.2 Reset Defaults

The following table supplies the default configuration item values for this model of the RC3000.

Space has also been provided to record installation specific changes to the configuration items. Note: recording of installation specific changes to defaults may prove valuable when trying to restore system configuration.

CONFIGURATION ITEM	U2 Default					INSTALL VALUE
SYSTEM DEFINITION						
GPS	1					
COMPASS MOUNT	2					
MODE	2					
antenna_size_cm	380					
Waveguide	0					
ELEVATION CALIBRATION						
Zero Voltage	1.69					
Elev_offset	0.0					
Up_elev_limit	90					
Down_elev_limit	0					
Elevation_Scale_Factor	50.00					
Elevation_look_configuration	1					
AZIMUTH CALIBRATION						
Reference Voltage	2.50					
Fluxgate_offset	0.0					
ccw_azim_limit	135					
Cw_azim_limit	135					
Azim_Scale_Factor	56.2					
POLARIZATION CAL						
Zero Voltage	2.50					
Polarization_Offset	0.0					
CW Polarization Limit	100.0					
CCW Polarization Limit	100.0					
Pol_Scale_Factor	43.19					
Polarization_type	2					
H/V_Reference	1					
Default Horizontal Position	-45.0					
Default Vertical Position	45.0					
Pol_Automove_Enable	1					

CONFIGURATION ITEM	U2 Default					INSTALL VALUE
SIGNAL PARAMETERS						
RF Lock Type	0					
RF Delay	0.1					
Channel 1 Polarity	1					
Channel 1 Threshold	100					
Channel 1 Delay	0.1					
Channel 1 Lock Type	0					
Channel 2 Polarity	1					
Channel 2 Threshold	100					
Channel 2 Delay	0.1					
Channel 2 Lock Type	0					
AUTOPEAK						
Autopeak Enabled	0					
Signal Source	1					
RF Band	1					
Spiral Search AZ Limit	3					
Spiral Search EL Limit	3					
Spiral Signal Threshold	200					
Scan Range Limit	8					
Scan Signal Threshold	200					
Tilt Compensation	0					

CONFIGURATION ITEM	U2 Default					INSTALL VALUE
AZIMUTH POT DRIVE						
Fast/Slow Threshold	2.5					
Maximum Position Error	0.20					
Coast Threshold	0.1					
Maximum Retry Count	3					
AZIMUTH PULSE DRIVE						
Pulse Scale Factor	2406					
CW Pulse Limit	64000					
CCW Pulse Limit	100					
Fast/Slow Threshold	50					
Maximum Position Error	0					
Coast Threshold	3					
Maximum Retry Count	3					
AZIM DRIVE MONITORING						
Jam Slop	1					
Runaway Slop	200					
Fast Deadband	1000					
Slow Deadband	500					
ELEV POT DRIVE						
Fast/Slow Threshold	3.0					
Maximum Position Error	0.2					
Coast Threshold	0.4					
Maximum Retry Count	3					
ELEV PULSE DRIVE						
Pulse Scale Factor	1646					
UP Pulse Limit	64000					
Down Pulse Limit	100					
Fast/Slow Threshold	50					
Maximum Position Error	0					
Coast Threshold	3					
Maximum Retry Count	3					
ELEV DRIVE MONITORING						
Jam Slop	1					
Runaway Slop	200					
Fast Deadband	1000					
Slow Deadband	500					
POL POT DRIVE						
Fast/Slow Threshold	2.0					
Maximum Position Error	0.5					
Coast Threshold	0.3					
Maximum Retry Count	3					
POL DRIVE MONITORING						
Jam Slop	1					
Runaway Slop	200					
Fast Deadband	1000					
Slow Deadband	500					

CONFIGURATION ITEM	U2 Default					INSTALL VALUE
TRACK						
Search Enable	0					
Max Track Error	3					
Search Width	4					
Peakup Holdoff Time	120					
Track Signal Source	2					
Signal Sample Time	2					
REMOTE CONTROL						
Remote Enabled	1					
Bus Address	50					
Baud Rate	6					
Jog Duration	20					
STOW / DEPLOY						
AZ STOW	0.0					
EL STOW	-67.5					
PL STOW	0.0					
AZ DEPLOY	0.0					
EL DEPLOY	22.6					
PL DEPLOY	0.0					
PL ENABLED	2					
EL_TIME	0					
SHAKE						
AZ1	-40.0					
EL1	30.0					
PL1	-10.0					
AZ2	50.0					
EL2	40.0					
PL2	10.0					
AZ3	0.0					
EL3	-67.5					
PL3	0.0					
CYCLES	5					
DELAY	1					

4.0 Schematics

Antenna Control Unit (ACU)

The U2 embedded controller utilizes many of the same cards and components used in the standard RC3000 rack mounted units. Schematics for these items may be found in the baseline RC3000 manual or optional appendices. Unique schematics for the embedded version of the controller are included here.

Block Diagram - This diagram shows internal connections and cabling to the external (E_) connectors.

Emb3k Breakout - These schematics (3 pages) details the "Breakout" card used to route signals between internal components and the external connectors.

Antenna Interface Unit (AIU)

Diagrams are provided for the ACU/AIU interconnection, the internal AIU relay card and the handheld remote.

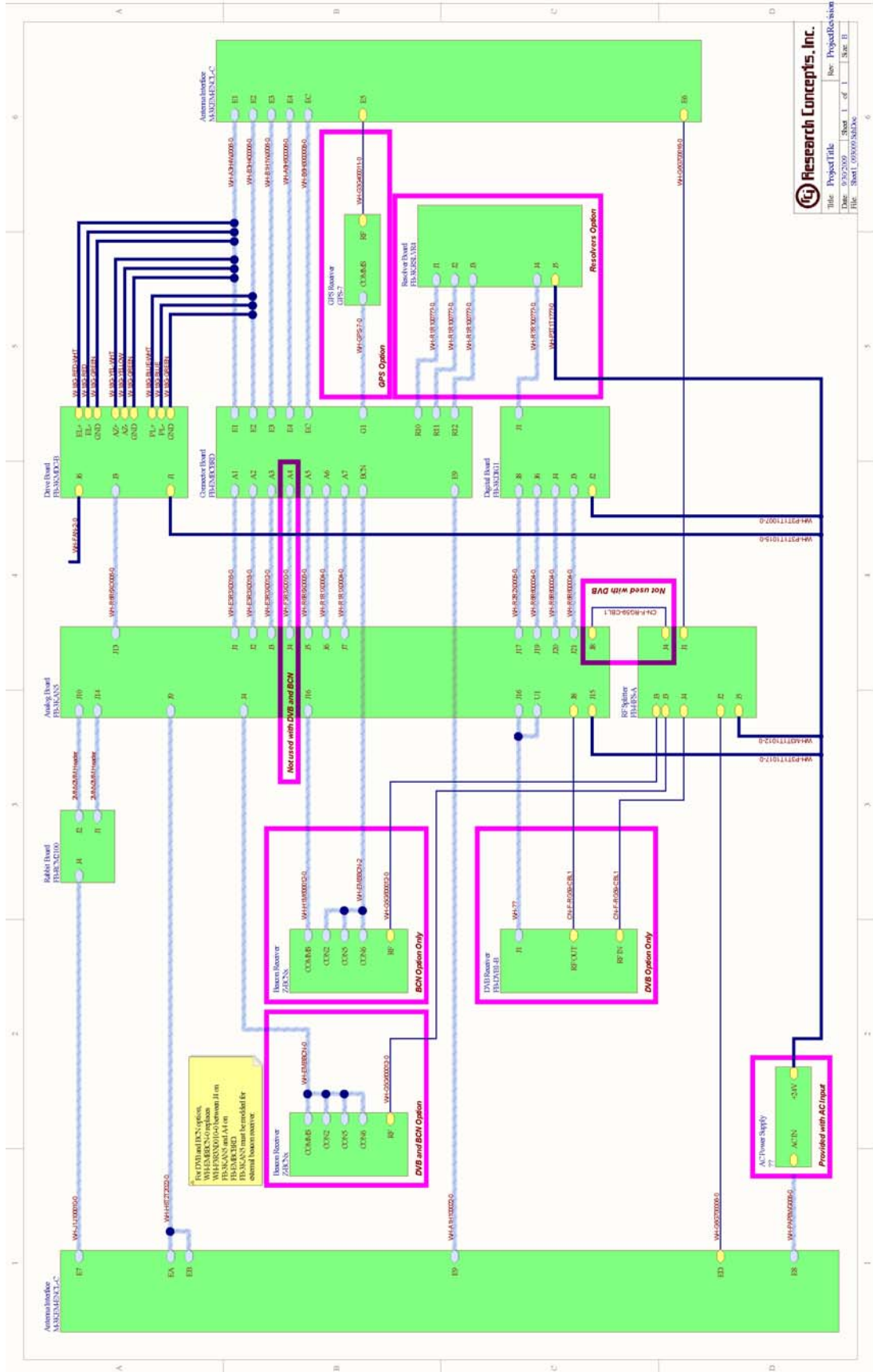

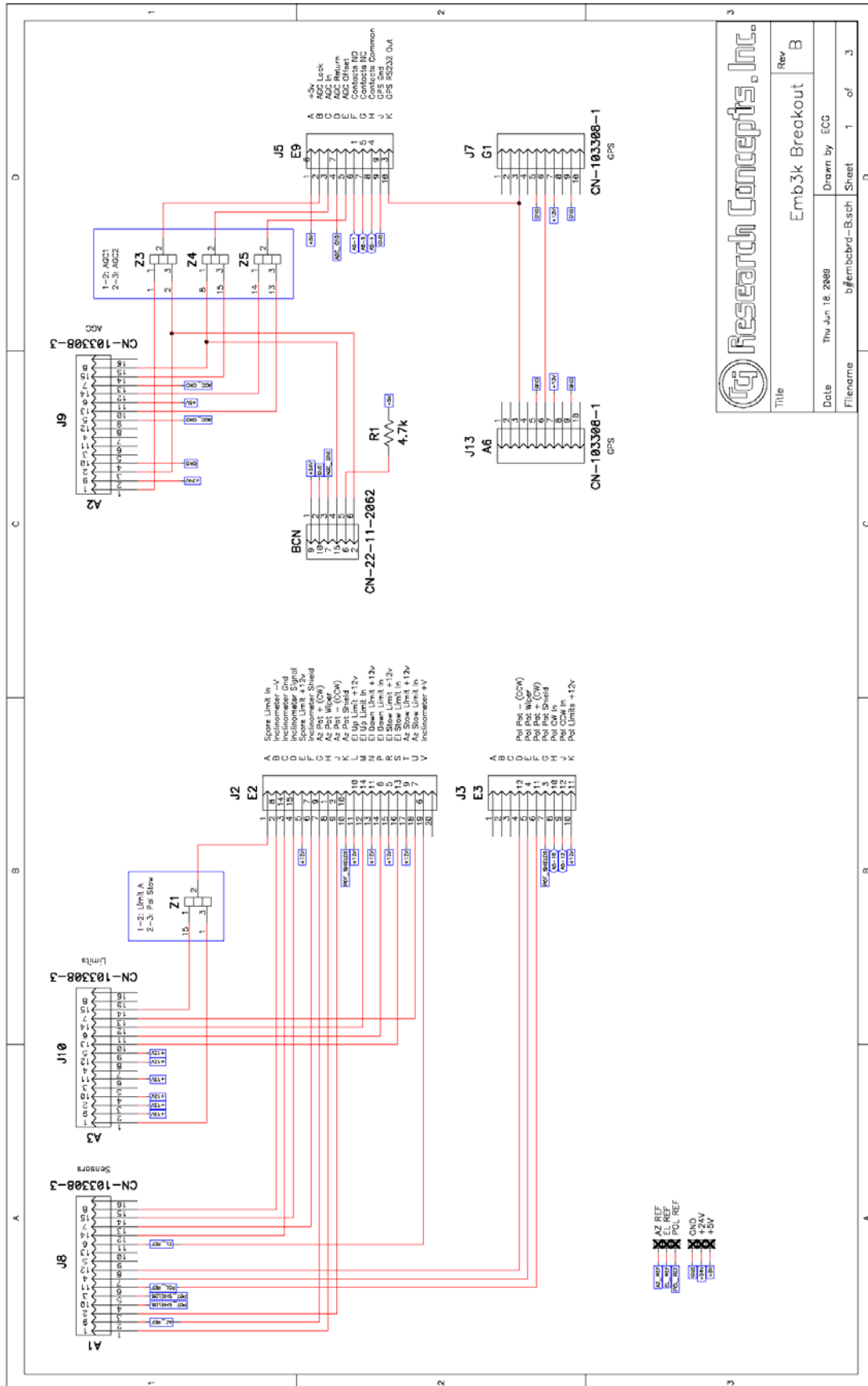

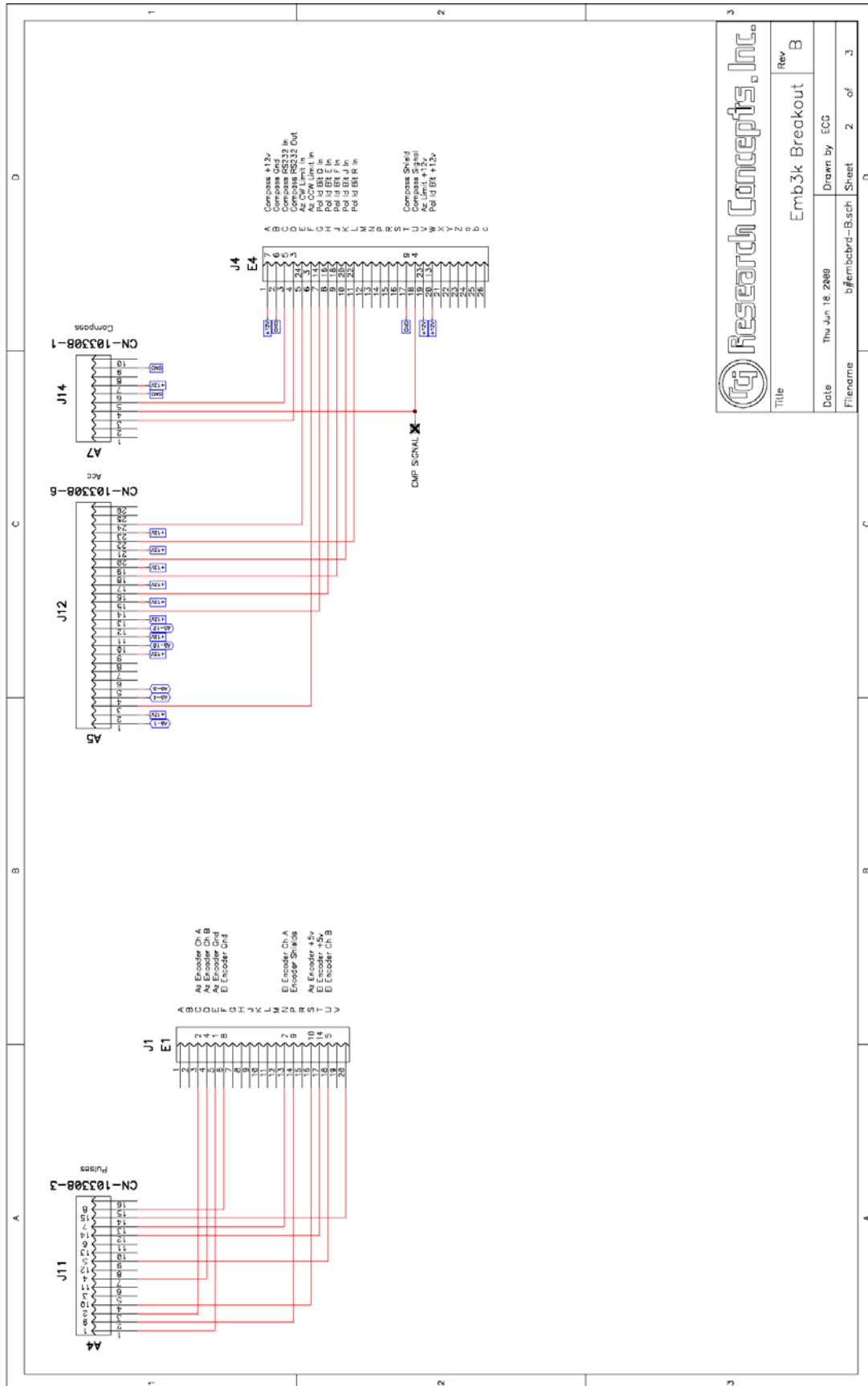

Research Concepts, Inc.

Title: Emb3k Breakout Rev B

Date: Thu Jun 18 2009 Drawn by: ECG

Filename: b#emb3kbrd-B.sch Sheet: 2 of 3

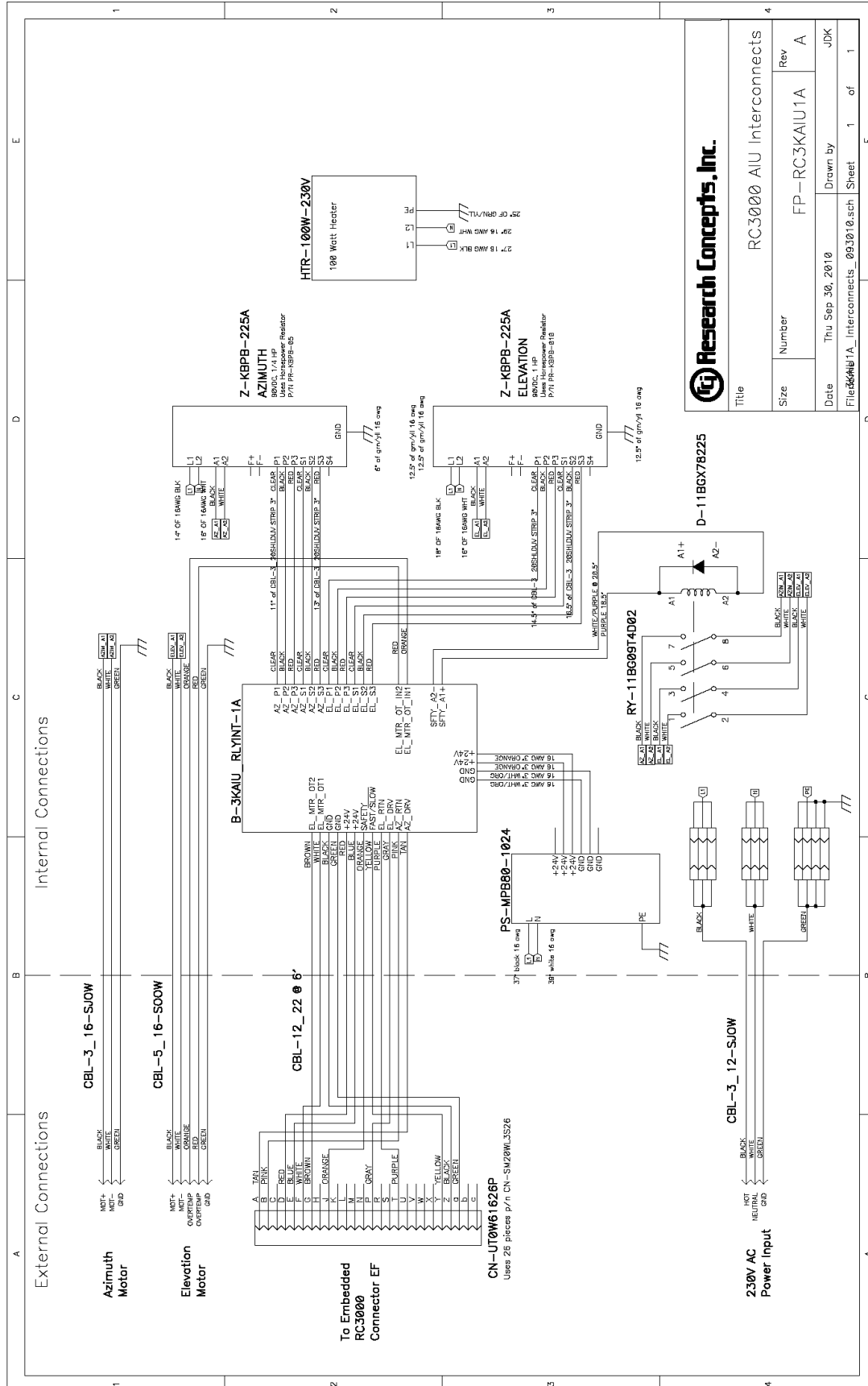

Research Concepts, Inc.	
Title	RC3000 AIU Interconnects
Size	Number
Rev	A
Date	Thu Sep 30, 2010
Drawn by	JDK
Sheet	1 of 1

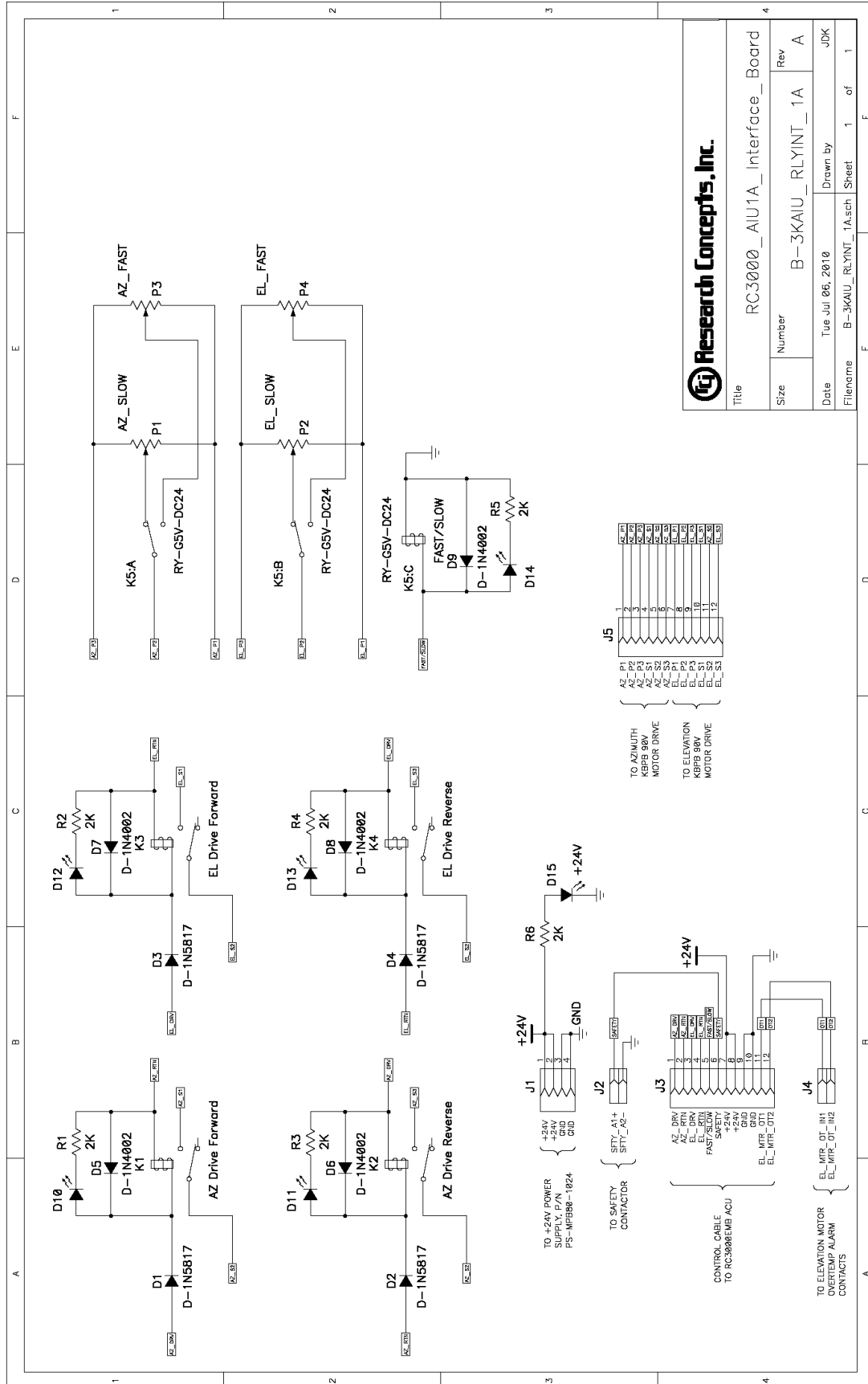

Research Concepts, Inc.

Title: RC3000_AIU1A_Interface_Board

Size	Number	Rev
	B-3KAU_RLYINT_1A	A

Date: Tue Jul 06, 2010
 Drawn by: JJK

Filename: B-3KAU_RLYINT_1A.sch Sheet 1 of 1

