

APPENDIX B - MOUNT SPECIFIC DATA

for the Vertex 1.8m. FlyAway

Revision: 14 December 2009, Software Version 1.60

1.1 Appendix B Organization

This appendix is provided as a supplement to the baseline RC3000 User's Manual. The corresponding paragraphs in the baseline RC3000 manual are referred to when data specific to the referenced mount is described.

1.2 Mount Model

This appendix describes the RC3000 antenna controller unit variation built for use by the Vertex 1.8m FlyAway antenna. This mount model type is designated as "KA".

1.3.2 System Interface Requirements

The KA mount follows the standard RC3000 interface requirements with a few exceptions:

- no azimuth STOW limit switch is utilized
- No front panel (LCD & keypad) exists for this variation of the RC3000 ACU. Front Panel control is mechanized by remote control either via a serial or Ethernet interface. See appendix REM for description of the serial interface or appendix IP for description of the Ethernet interface.
- Instead of the baseline fluxgate compass, a smaller Single Axis Compass is utilized. See appendix SAC for description of the Single Axis Compass.
- Instead of the baseline GPS receiver unit, an embedded GPS receiver with a separate smaller antenna is used.
- Interfaces are mechanized by waterproof connectors detailed in subsequent paragraphs of this appendix.

2.0 INSTALLATION

2.1.1 RC3000 Antenna Controller

For the KA mount, the ACU is mechanized as an "embedded" controller. Rather than being a rack-mounted unit, the KA ACU is contained in a weatherproof enclosure.

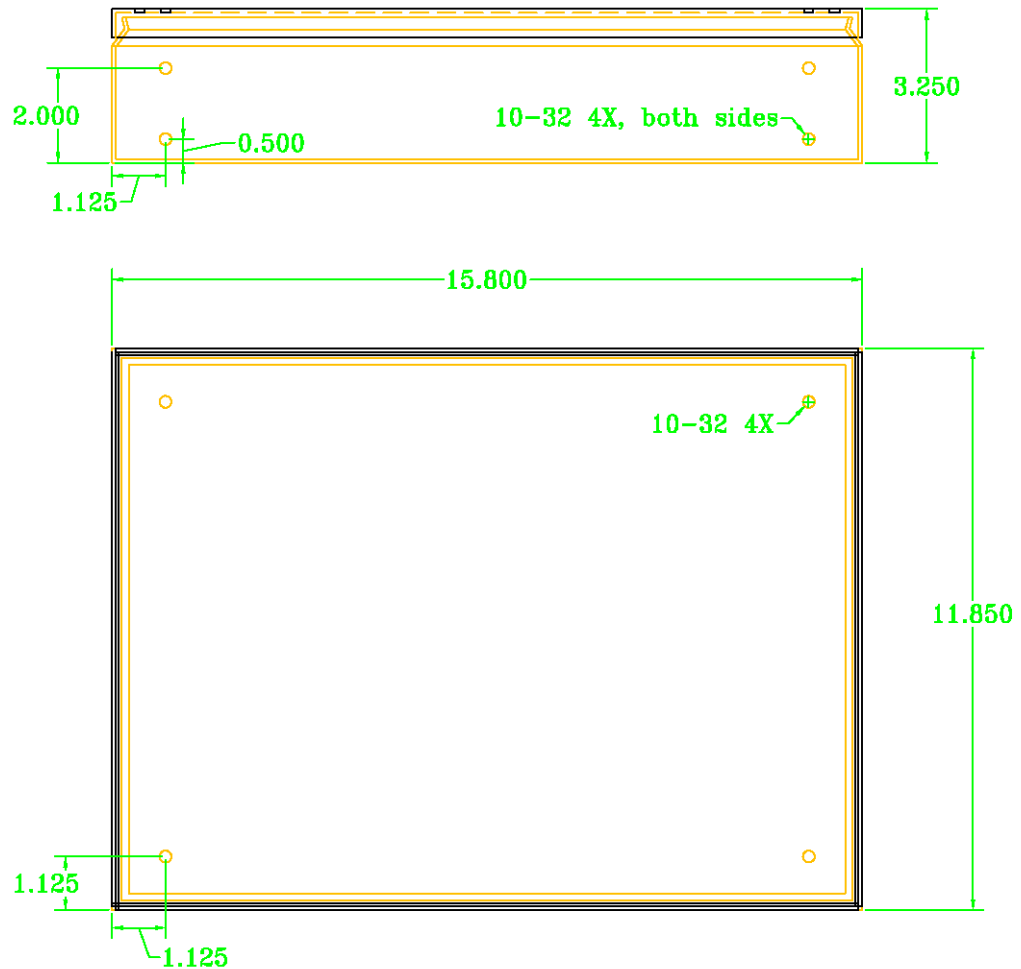

2.1.2 GPS

The KA controller uses an embedded GPS receiver which externally interfaces to a small GPS antenna via a TNC connector.

2.1.3 Compass

The KA controller utilizes a "single axis compass" rather than the fluxgate compass described in the baseline RC3000 manual. Please refer to appendix SAC for details concerning the single axis compass.

2.1.4 Inclinometer Orientation

The inclinometer should be rigged with the face of the reflector vertical.

2.2 Electrical Connections

The following diagrams depict the weatherproof connectors that are mounted at either end of the embedded enclosure.

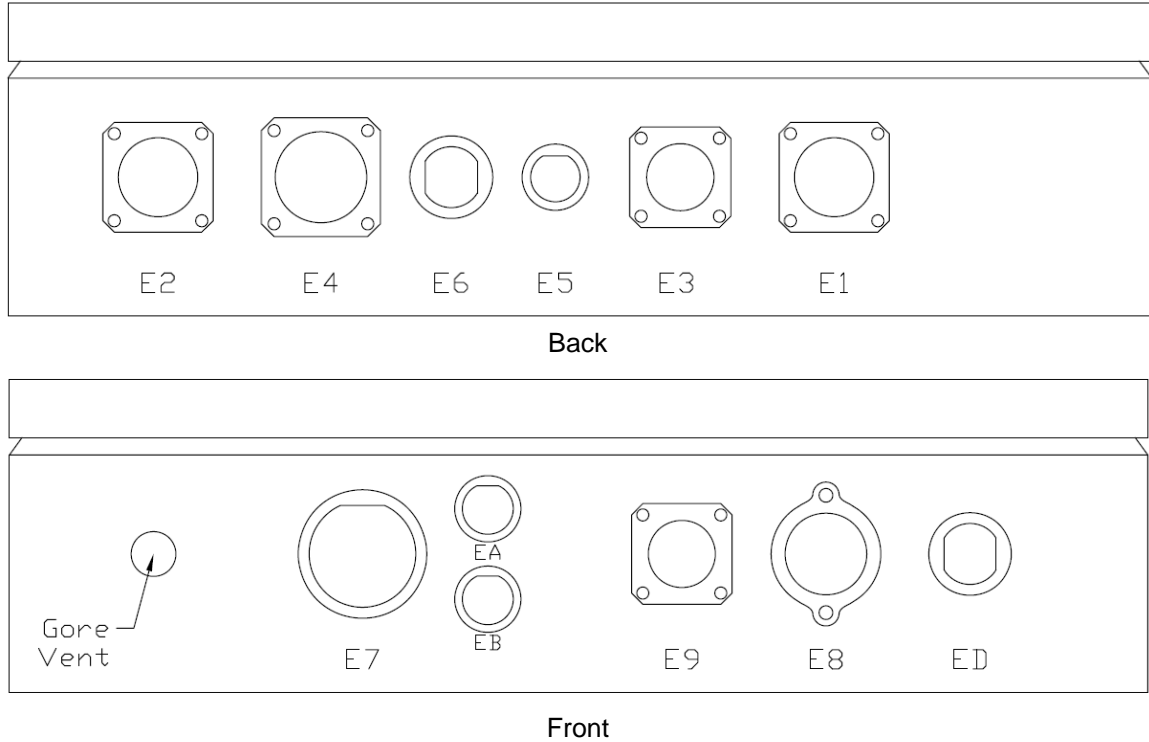

2.2.1-13 Connection Schedule

The interfaces described in sections 2.2.1 through 2.2.13 of the baseline manual are implemented through connectors E1 to ED on the embedded controller. To accommodate more efficient cabling, some interfaces have been reallocated per the following schedule.

VN connector	Description	Baseline Manual Reference / Comments
E1	Az/EI Motors & Pulses	2.2.2, 2.2.10
E2	Az/EI Sensors	2.2.3, 2.2.4,
E3	Pol Motors & Sensors	2.2.2, 2.2.3, 2.2.4
E4	Antenna Accessories & Compass	2.2.7
E5	GPS Antenna	TNC connector
E6	RF In / LNB Power	F connector
E7	Ethernet	RJ45 connector
E8	Power	2.2.1
E9	Modem Accessories	* jumpering required * (see 2.4.3 of this appendix)
EA	Red Button	
EB	Green Button	
EC	Resolvers	2.2.13
ED	RF Out	

The following diagrams detail the pinouts of various connectors. The major polarizing notch is considered to be the top of each connector. All pins are shown from a front view of each connector.

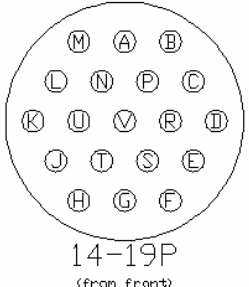
Reference	E1	
Description	Az/EI Motors & Encoders	
RCI P/N	CN-MS31221419P	
Manufacturer	Amphenol Industrial	
Manufacturer P/N	MS3122E-14-19P	

Pin	Description	Notes
A	Az Motor +	
B		
C	Az Encoder Ch A	
D	Az Encoder Ch B	
E	Az Encoder Gnd	
F	EI Encoder Gnd	
G		
H	Az Motor -	
J	EI Motor -	
K		
L		
M	EI Motor +	
N	EI Encoder Ch A	
P	Encoder Shields	
R	Az Motor Shield	
S	Az Encoder +V	
T	EI Encoder +V	
U	EI Encoder Ch B	
V	EI Motor Shield	

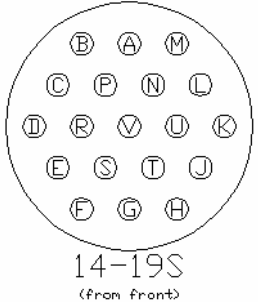
Reference	E2	
Description	Az/EI Position Sensors & Limits	
RCI P/N	CN-MS31221419S	
Manufacturer	Amphenol Industrial	
Manufacturer P/N	MS3122E-14-19S	

Pin	Description	Notes
A		
B	Inclinometer -V	Not required for ratiometric
C	Inclinometer Gnd	
D	Inclinometer Signal	
E		
F	Inclinometer Shield	
G	Az Pot + (CW)	
H	Az Pot Wiper	
J	Az Pot - (CCW)	
K	Az Pot Shield	
L	EI Up Limit +V	
M	EI Up Limit In	
N	EI Down Limit +V	
P	EI Down Limit In	
R	EI Stow Limit +V	EI Down Disable +V (VN)
S	EI Stow Limit In	EI Down Disable In (VN)
T	Az Stow Limit +V	
U	Az Stow Limit In	
V	Inclinometer +V	+5v for ratiometric

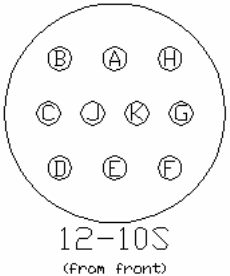
Reference	E3	
Description	Pol Motor, Sensors, & Limits	
RCI P/N	CN-MS31221210S	
Manufacturer	Amphenol Industrial	
Manufacturer P/N	MS3122E-12-10S	

Pin	Description	Notes
A	Pol Motor +	
B	Pol Motor -	
C	Pol Motor Shield	
D	Pol Pot - (CCW)	As of Rev 2
E	Pol Pot Wiper	
F	Pol Pot + (CW)	As of Rev 2
G	Pol Pot Shield	
H	Pol CW Limit In	
J	Pol CCW Limit In	
K	Pol Limits +V	

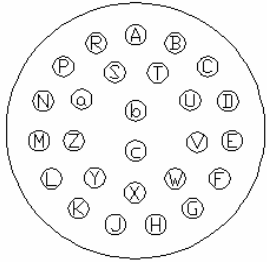
Reference	E4	 <p>16-26P (from front)</p>
Description	Compass, Accessories	
RCI P/N	CN-MS31221626P	
Manufacturer	Amphenol Industrial	
Manufacturer P/N	MS3122E-16-26P	

Pin	Description	Notes
A	Compass +V	
B	Compass Gnd	
C	Compass RS232 In	
D	Compass RS232 Out	
E	Az CW Limit In	
F	Az CCW Limit In	
G	Pol ID Bit D In	
H	Pol ID Bit E In	
J	Pol ID Bit F In	
K	Pol ID Bit J In	
L	Pol ID Bit R In	
M		
N		
P		
R		
S		
T	Compass Shield	
U	Compass Signal	
V	Az Limits +V	
W	Pol ID Bits +V	
X		
Y		
Z		
a		
b		
c		

Reference	E5
Description	GPS Antenna, 50-Ohm TNC
RCI P/N	CN-122192
Manufacturer	Amphenol RF
Manufacturer P/N	122192

Pin	Description	Notes
1	Center Conductor	
2	Shield	

Reference	E6
Description	RF Input, 50 Ohm N-Type
RCI P/N	CN-172129
Manufacturer	Amphenol RF
Manufacturer P/N	172129

Pin	Description	Notes
1	Center Conductor	
2	Shield	

Reference	E7
Description	Ethernet Interface
RCI P/N	CN-1738601-1
Manufacturer	Tyco Electronics
Manufacturer P/N	1738601-1

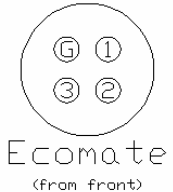
Reference	E8	
Description	VAC/VDC Power Input	
RCI P/N	CN-C01620C312	
Manufacturer	Amphenol-Tuchel	
Manufacturer P/N	C016 20C003 100 12	

Pin	Description	Notes
1	Neutral	
2	Line	
3	+VDC	Only used on DC input model
G	Gnd	

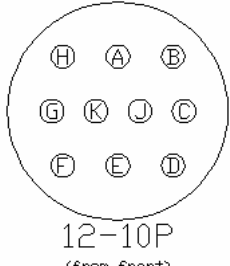
Reference	E9	
Description	Modem Interface	
RCI P/N	CN-MS31221210P	
Manufacturer	Amphenol Industrial	
Manufacturer P/N	MS3122E-12-10P	

Pin	Description	Notes
A	+5v	Max 150 mA
B	AGC Lock In	
C	AGC Signal In	
D	AGC Common	
E	AGC Offset Out	
F	HPA Contacts NO	
G	HPA Contacts NC	
H	HPA Contacts Common	
J	GPS Gnd	
K	GPS RS232 Loopout	

Reference	EA
Description	Red Button
RCI P/N	SW-LRTITO6R19G
Manufacturer	Oslo Switch
Manufacturer P/N	LRTITO6R19G

Reference	EB
Description	Green Button
RCI P/N	SW-LRTITO6G49G
Manufacturer	Oslo Switch
Manufacturer P/N	LRTITO6G49G

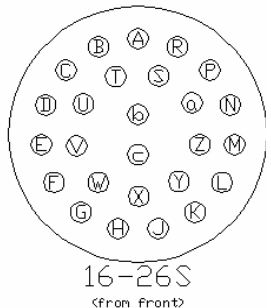
Reference	EC	
Description	Az/EI/Pol Resolvers	
RCI P/N	CN-MS31221626S	
Manufacturer	Amphenol Industrial	
Manufacturer P/N	MS3122E-16-26S	

Pin	Description	Notes
A	Az Sin +	
B	Az Sin -	
C		
D	Az Cos +	
E	Az Cos -	
F	EI Sin +	
G	EI Sin -	
H		
J	EI Cos +	
K	EI Cos -	
L	Pol Sin +	
M	Pol Sin -	
N		
P	Pol Cos +	
R	Pol Cos -	
S	Pol Ref -	
T	Az Ref +	
U	Az Drain	
V	Az Ref -	
W	EI Ref +	
X	EI Drain	
Y	EI Ref -	
Z	Pol Ref +	
a	Pol Drain	
b		
c		

Reference	ED
Description	RF Output, 50 Ohm N-Type
RCI P/N	CN-172129
Manufacturer	Amphenol RF
Manufacturer P/N	172129

Pin	Description	Notes
1	Center Conductor	
2	Shield	

2.3.2 Elevation Calibration

Elevation Reference Position

From the vertical reflector position, the elevation reference voltage should be close to 1.1 V. The elevation displayed at this voltage will be 18.8 reflecting the mount's RF elevation offset.

2.4.3 External Signal Strength Adjustment

The Modem Accessories connector (E9) allows one external signal strength channel (AGC voltage and discrete signal lock) to be supplied to the embedded controller. Depending on the options present on a particular controller, this external signal strength channel may need to be vectored to the RC3000's internal SS1 or SS2 input.

For example, if an optional beacon receiver is present, its AGC voltage and lock signal will be routed internally to SS2. Therefore, any external signal strength channel will need to be vectored to SS1.

To accomplish the vectoring of an external signal strength channel, jumpers Z3, Z4 and Z5 on the Emb3k Breakout card must be set correctly. To vector to SS1 all three jumpers should be set between pins 1 and 2. To vector to SS2 all three jumpers should be set between pins 2 and 3. NOTE: pin 1 of each jumper is closest to the Z# designator on the card. See page 1 of the Emb3k Breakout schematic in section 4.

The SS1 or SS2 input channels must be adjusted correctly according to the characteristics of the AGC voltage coming from an external signal strength source. This procedure is quite involved and is discussed in section 2.4.3 (Signal Strength Adjustment) of the baseline manual. On rack mounted units, four potentiometers are accessible at the backpanel of the controller. On an embedded controller, these potentiometers must be adjusted inside the unit.

There are four blue, vertical pots designated P1-P4 on board B#3KAN5. These pots are labeled G1, O1, G2, O2 respectively. For AGC1, use O1 to adjust the offset and G1 to adjust the gain. For AGC2, use O2 to adjust the offset and G2 to adjust the gain.

3.0 Detailed Operation

The KA version of the RC3000 operates as described in the baseline RC3000 User's Manual.

3.1.2 Keypad Operation

Since no actual keypad exists for the KA version, user inputs must be made via a "Remote Front Panel" application implemented either via the serial or Ethernet remote interfaces.

3.3.1.2 Reset Defaults

The following table supplies the default configuration item values for this model of the RC3000.

Space has also been provided to record installation specific changes to the configuration items. Note: recording of installation specific changes to defaults may prove valuable when trying to restore system configuration.

CONFIGURATION ITEM	KA Default					INSTALL VALUE
SYSTEM DEFINITION						
GPS	1					
COMPASS MOUNT	2					
MODE	2					
antenna_size_cm	180					
Waveguide	0					
ELEVATION CALIBRATION						
Zero Voltage	2.50					
Elev_offset	0.0					
Up_elev_limit	90					
Down_elev_limit	5					
Elevation_Scale_Factor	40.07					
Elevation_look_configuration	1					
AZIMUTH CALIBRATION						
Reference Voltage	2.50					
Fluxgate_offset	-90.0					
ccw_azim_limit	120					
Cw_azim_limit	120					
Azim_Scale_Factor	75.0					
POLARIZATION CAL						
Zero Voltage	2.50					
Polarization_Offset	0.0					
CW Polarization Limit	90.0					
CCW Polarization Limit	90.0					
Pol_Scale_Factor	37.50					
Polarization_type	2					
H/V_Reference	0					
Default Horizontal Position	0.0					
Default Vertical Position	90.0					
Pol_Automove_Enable	1					

CONFIGURATION ITEM	KA Default					INSTALL VALUE
SIGNAL PARAMETERS						
RF Lock Type	0					
RF Delay	0.1					
Channel 1 Polarity	1					
Channel 1 Threshold	100					
Channel 1 Delay	0.1					
Channel 1 Lock Type	0					
Channel 2 Polarity	1					
Channel 2 Threshold	100					
Channel 2 Delay	0.1					
Channel 2 Lock Type	0					
AUTOPEAK						
Autopeak Enabled	0					
Signal Source	1					
RF Band	1					
Spiral Search AZ Limit	3					
Spiral Search EL Limit	3					
Spiral Signal Threshold	200					
Scan Range Limit	8					
Scan Signal Threshold	200					
Tilt Compensation	0					

CONFIGURATION ITEM	KA Default					INSTALL VALUE
AZIMUTH POT DRIVE						
Fast/Slow Threshold	2.5					
Maximum Position Error	0.20					
Coast Threshold	0.1					
Maximum Retry Count	3					
AZIMUTH PULSE DRIVE						
Pulse Scale Factor	1090					
CW Pulse Limit	65000					
CCW Pulse Limit	1					
Fast/Slow Threshold	50					
Maximum Position Error	1					
Coast Threshold	0					
Maximum Retry Count	3					
AZIM DRIVE MONITORING						
Jam Slop	1					
Runaway Slop	400					
Fast Deadband	1000					
Slow Deadband	500					
ELEV POT DRIVE						
Fast/Slow Threshold	2.0					
Maximum Position Error	0.2					
Coast Threshold	0.2					
Maximum Retry Count	3					
ELEV PULSE DRIVE						
Pulse Scale Factor	1986					
UP Pulse Limit	65000					
Down Pulse Limit	105					
Fast/Slow Threshold	50					
Maximum Position Error	1					
Coast Threshold	0					
Maximum Retry Count	3					
ELEV DRIVE MONITORING						
Jam Slop	1					
Runaway Slop	200					
Fast Deadband	1000					
Slow Deadband	500					
POL POT DRIVE						
Fast/Slow Threshold	2.0					
Maximum Position Error	0.5					
Coast Threshold	0.3					
Maximum Retry Count	3					
POL DRIVE MONITORING						
Jam Slop	1					
Runaway Slop	200					
Fast Deadband	1000					
Slow Deadband	500					

CONFIGURATION ITEM	KA Default					INSTALL VALUE
TRACK						
Search Enable	0					
Max Track Error	3					
Search Width	4					
Peakup Holdoff Time	120					
Track Signal Source	2					
Signal Sample Time	2					
REMOTE CONTROL						
Remote Enabled	1					
Bus Address	50					
Baud Rate	6					
Jog Duration	20					
STOW / DEPLOY						
AZ STOW	0.0					
EL STOW	91.0					
PL STOW	0.0					
AZ DEPLOY	0.0					
EL DEPLOY	18.8					
PL DEPLOY	0.0					
PL ENABLED	2					
EL_TIME	0					
SHAKE						
AZ1	-90.0					
EL1	30.0					
PL1	-5.0					
AZ2	90.0					
EL2	40.0					
PL2	5.0					
AZ3	0.0					
EL3	80.0					
PL3	0.0					
CYCLES	5					
DELAY	0					

4.0 Schematics

The KA embedded controller utilizes many of the same cards and components used in the standard RC3000 rack mounted units. Schematics for these items may be found in the baseline RC3000 manual or optional appendices. Unique schematics for the embedded version of the controller are included here.

Block Diagram - This diagram shows internal connections and cabling to the external (E_) connectors.

Emb3k Breakout - These schematics (3 pages) details the "Breakout" card used to route signals between internal components and the external connectors.

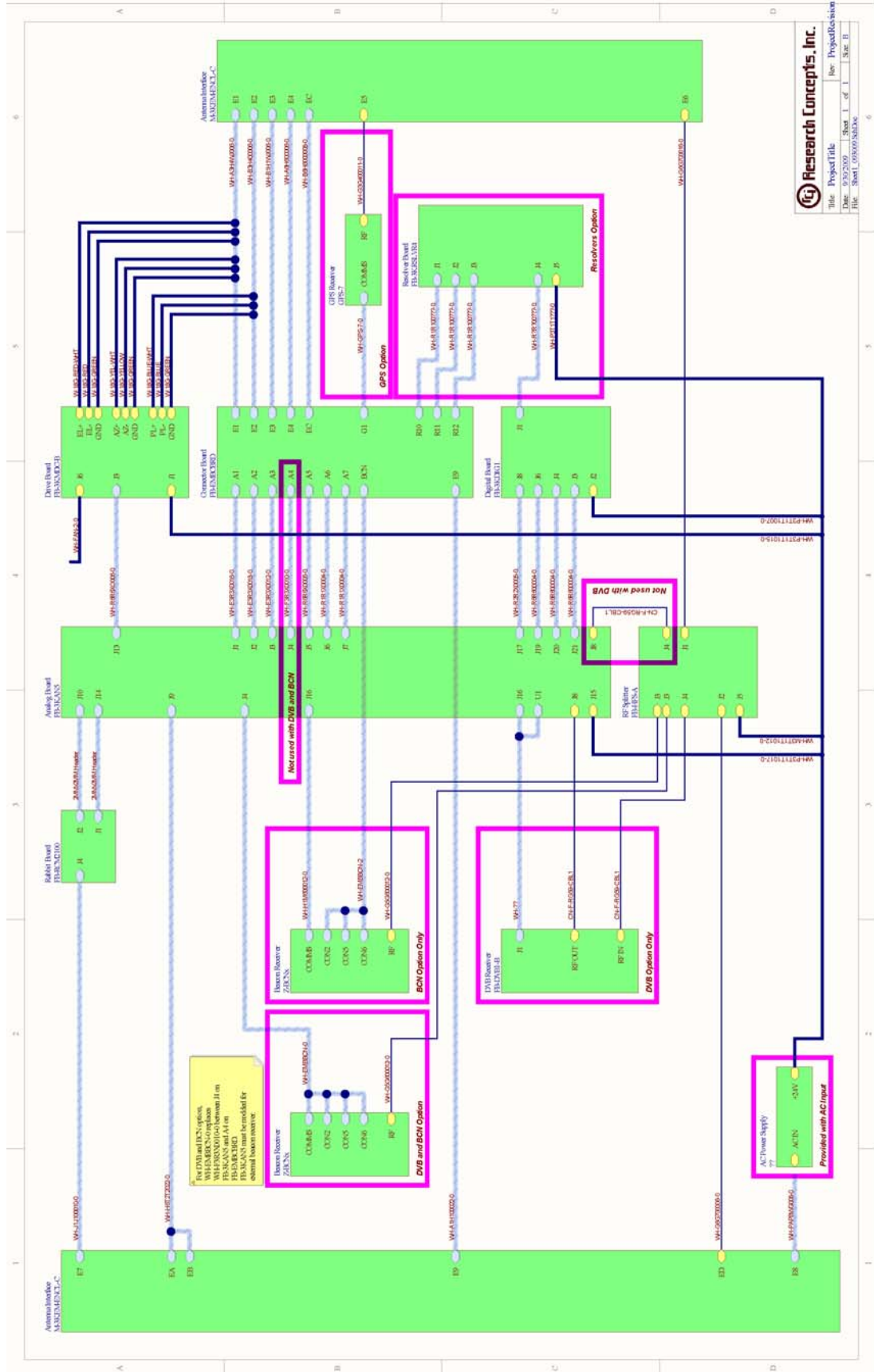

Research Concepts, Inc.
Title: Project File | Rev: Project Revision
Date: 09/25/2009 | Sheet 1 of 1 | Size B
File: SW1_09090303.DWG

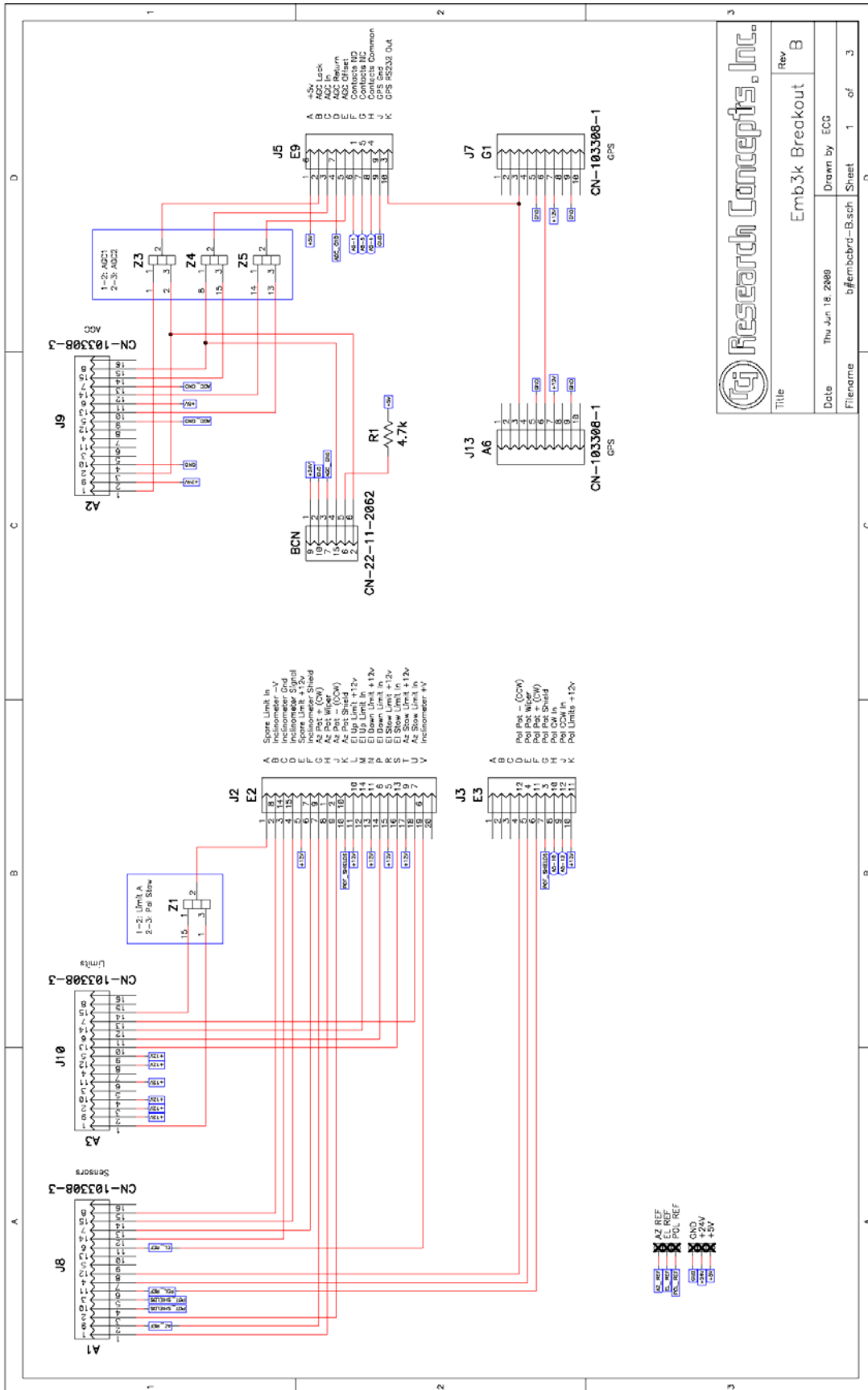

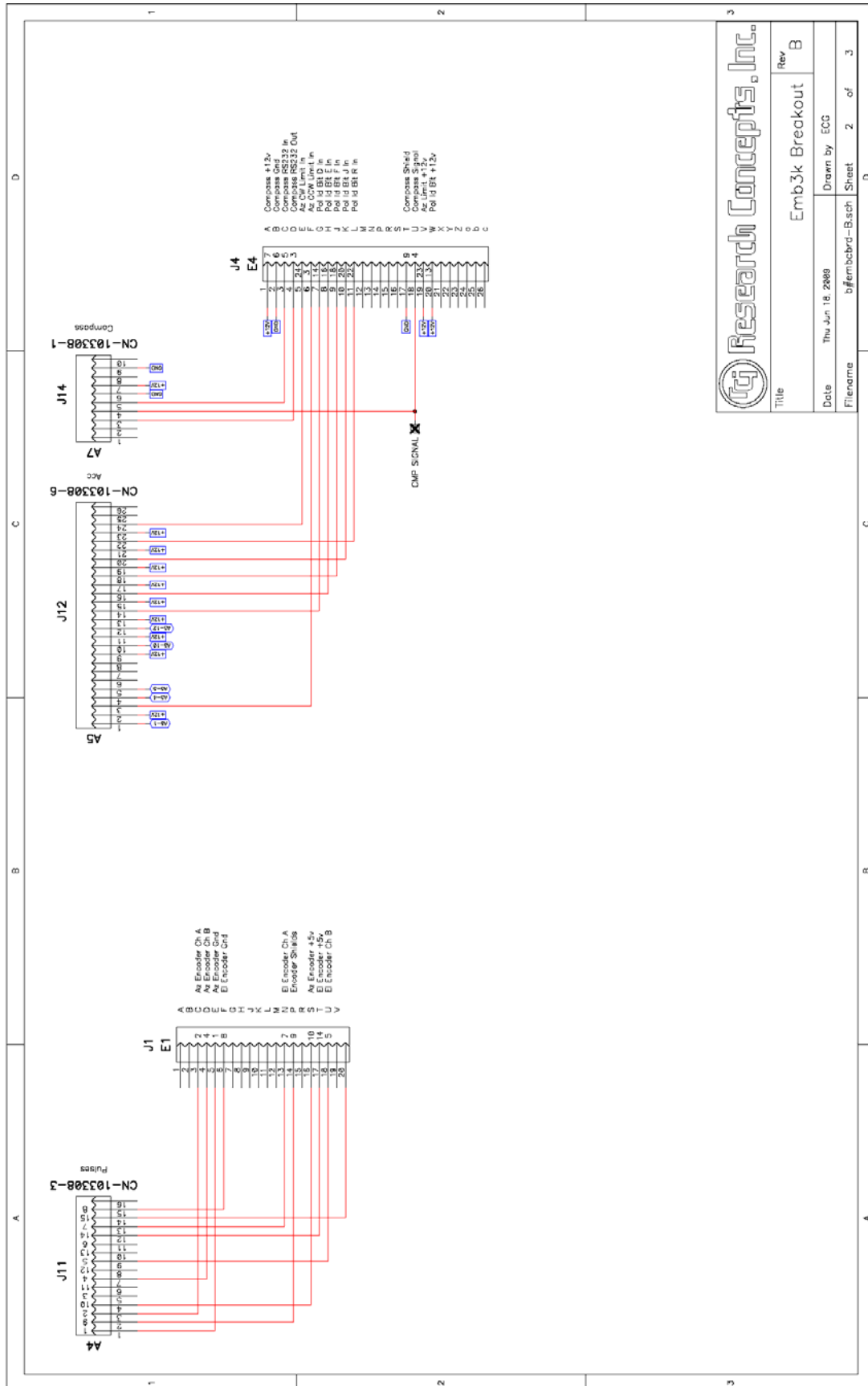

Research Concepts, Inc.

Title: Emb3k Breakout Rev B

Date: Thu Jun 18 2009 Drawn by: ECG

Filename: b#emb3kbrd-B.sch Sheet: 2 of 3

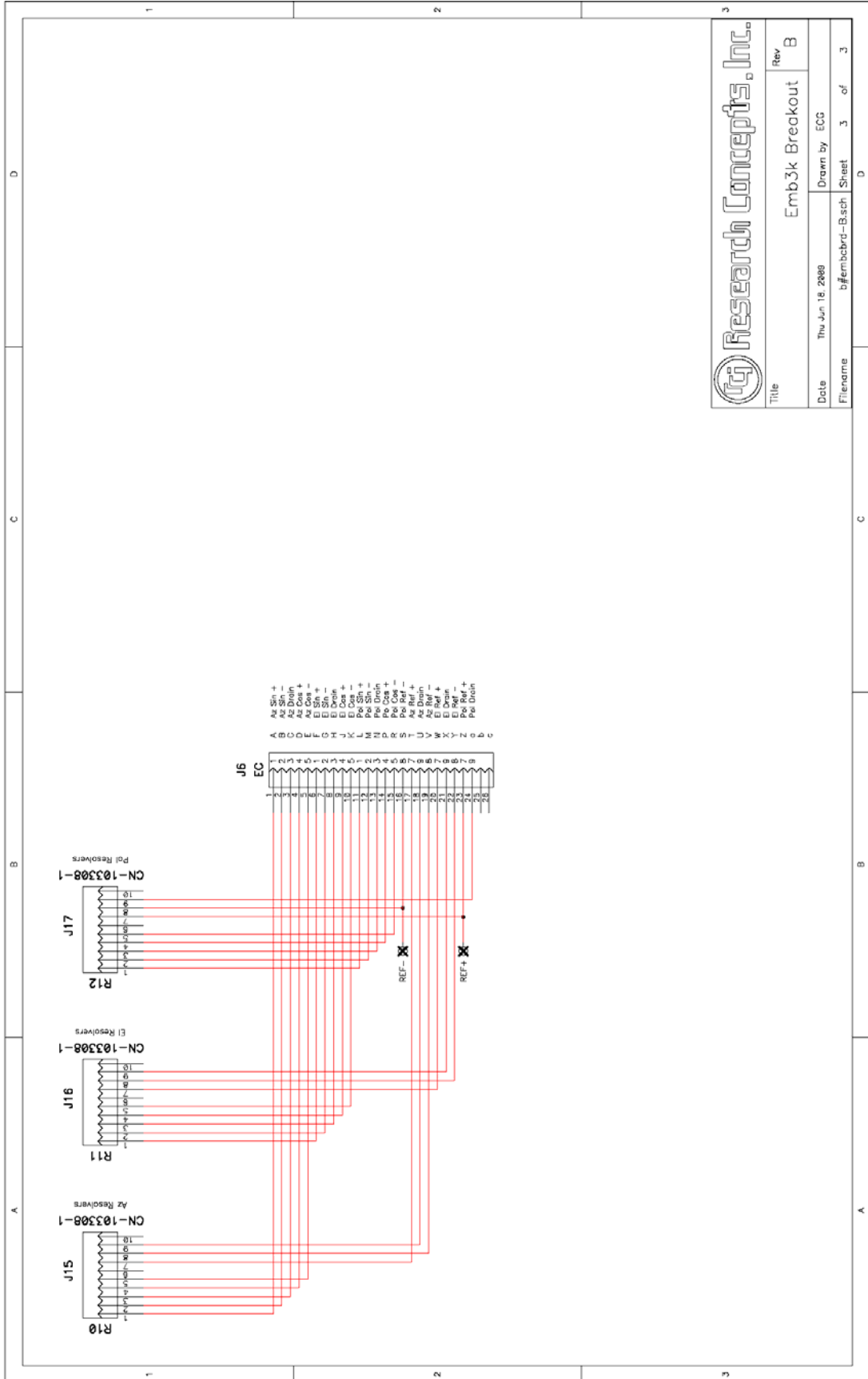

Research Concepts, Inc.

Title	Emb3k Breakout	Rev	B
Date	Thu Jun 18 2009	Drawn by	ECG
Filename	b:\emb3kbrd--Basch	Sheet	3 of 3