

Title RC3000 Feature Board			
Size B	Number 3	Revision KEA	Rev B
Date Mon May 04, 2009		Drawn by JFR	
Filename RC3000_Feature_Board_SCH		Sheet 1 of 4	

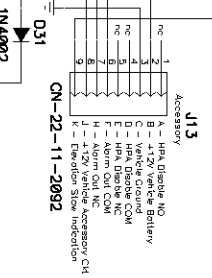
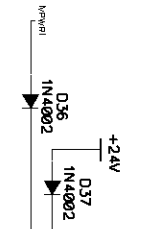
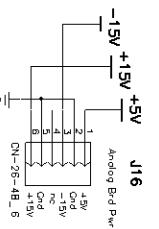
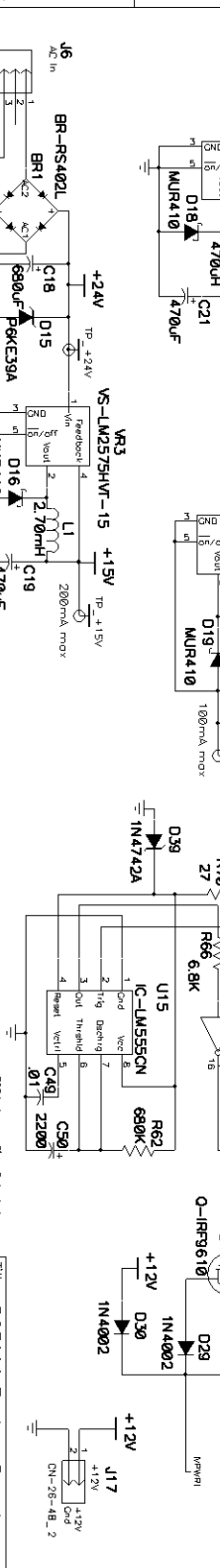
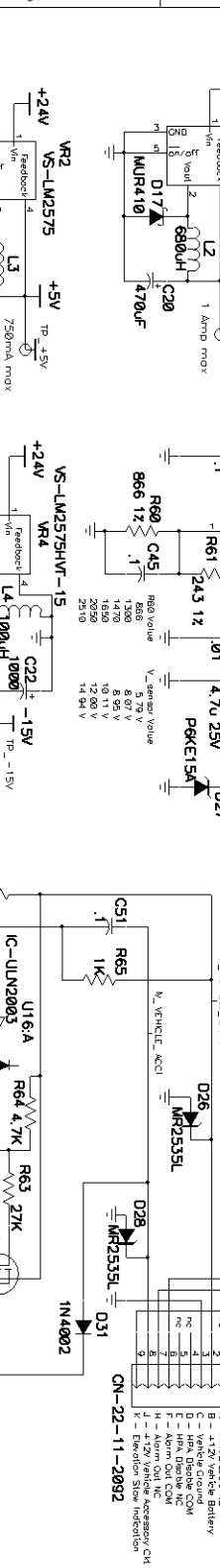
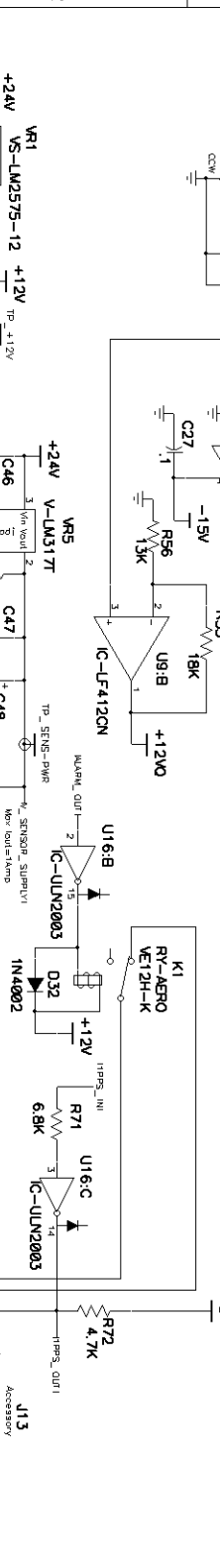
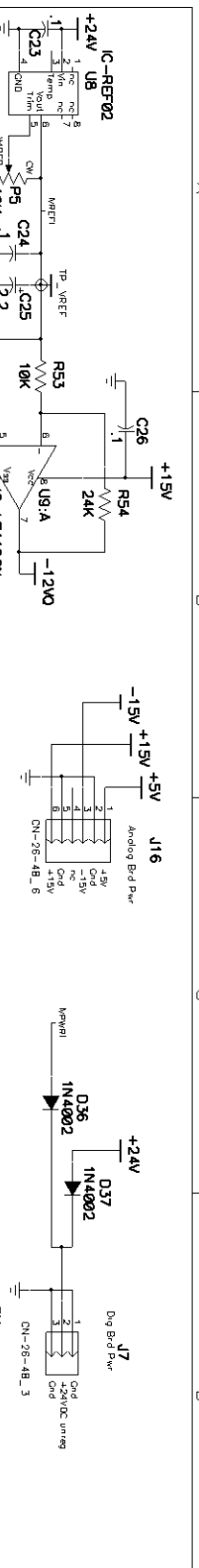

To Power MV, pins 1, 3, and 4 with white accessory voltage and Battery for a 1-delay of 100ms. To Power the Dig Board, pins 1, 3, and 4 with 1 VDC.

Res Value	Time Delay Value
100K	4.00 Min
20K	9.00 Min
20K	2.00 Min
20K	2.00 Min
20K	2.00 Min
1 MΩ	40.0 Min

Title	Size	Number	Date	Drawn by	Rev
RC3000 Feature Board	B	3KFEATUERSA	Mon May 04, 2009	JFR	B
Filename: RC3000_Feat_Brd_SCH				Sheet 3	of 4

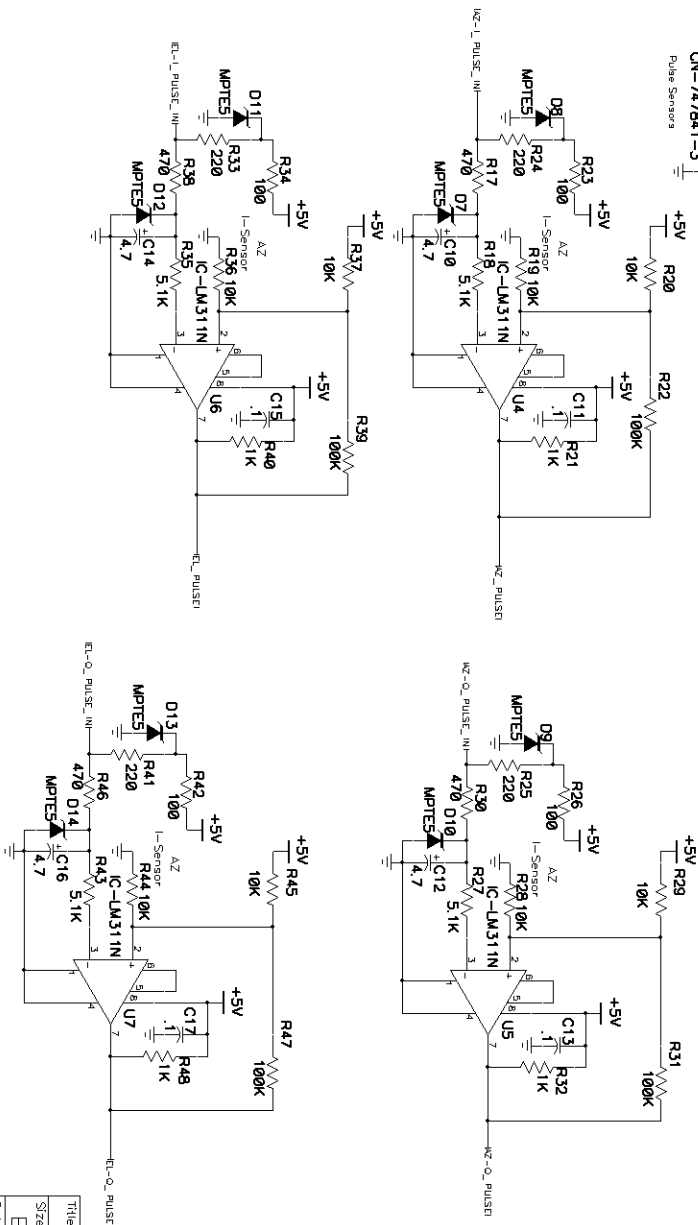
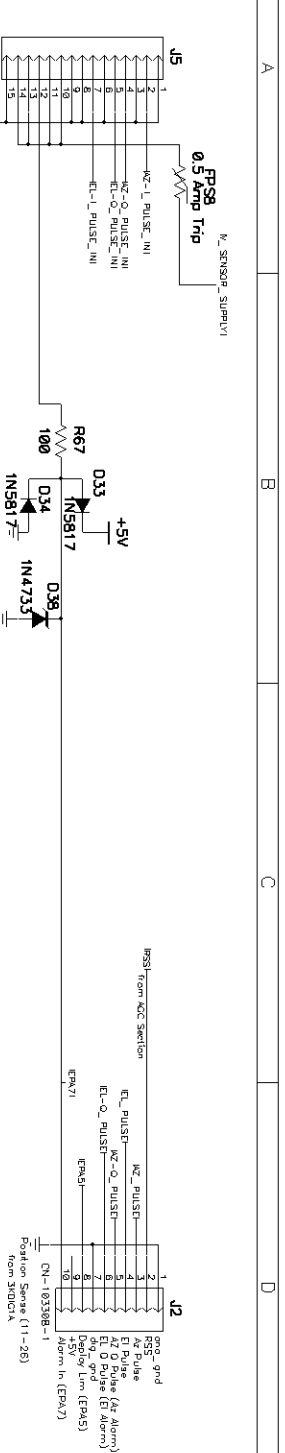

B - version corrects miswired feedback connection on pulse processors

Title RC3000 Feature Board			
Size B	Number 3KFEATURESA	Rev B	
Date Mon May 04, 2009	Drawn by JFR		
Filename 3Kfeature3B1.SCH	Sheet 4	of 4	